

Moisture Analyzer

INSTRUCTION MANUAL

MS-70

MX-50

MF-50

ML-50



AND

A&D Company, Limited

1WMPD4000477F

This manual and Marks

All safety messages are identified by the following, "WARNING" or "CAUTION", of ANSI Z535.4 (American National Standard Institute: Product Safety Signs and Labels). The meanings are as follows:

 WARNING	A potentially hazardous situation which, if not avoided, could result in death or serious injury.
 CAUTION	A potentially hazardous situation which, if not avoided, may result in minor or moderate injury.



This is a hazard alert mark.



This mark is the IEC417 mark for "Caution. Hot surface".
Do not touch parts affixed with this mark without adequate protection.



This mark informs you about the operation of the product.

- ❑ This manual is subject to change without notice at any time to improve the product.
- ❑ Product specifications are subject to change without any obligation on the part of the manufacturer.
- ❑ Under the copyright laws, the instruction manual and the software (program) described in it are copyrighted, with all rights reserved.
The software may be installed into one computer and may not be installed into other computers without the prior written consent of A&D Company. Copying includes translation into another language, reproduction, conversion, photocopy and offer or loan to another person.
- ❑ The purchaser may make one copy of the software for backup purposes.
The manual and the software may not be copied, in whole or part, except as described above.
- ❑ Windows is a registered trademark of the Microsoft Corporation.



Contents

1.	Safety and Compliance	3
2.	Precautions.....	6
2.1.	Installing the Analyzer.....	6
2.2.	During Use	7
2.3.	After Use and Maintaining the Analyzer	8
3.	Outline and Features.....	9
4.	Packing List and Names of each part.....	11
4.1.	Display and Keys	13
5.	Preparations	15
5.1.	Installing the Analyzer.....	15
5.2.	Setting the Clock and Calendar	16
5.2.1.	Operation	16
5.3.	Proper Operation for Precision Measurement	17
5.3.1.	Operation of the sample.....	17
5.3.2.	Operation of the analyzer	17
5.3.3.	The Glass Fiber Sheets	18
6.	Measurement Procedure	19
6.1.	Standard Mode Operation.....	19
6.1.1.	ACCURACY.....	19
6.1.2.	Operation	19
6.2.	Quick Mode Operation.....	22
6.2.1.	ACCURACY.....	22
6.2.2.	Operation	22
6.3.	Program Number	25
6.3.1.	Storing a Measurement Program to a Program Number.....	25
6.3.2.	Recalling a Measurement Program with a Program Number	25
7.	Measurement Programs	26
7.1.	List of Measurement Programs	26
7.1.1.	ACCURACY of the Standard Mode and Quick Mode	27
7.1.2.	Analyzing mode of the Automatic Mode	28
7.1.3.	Analyzing mode of the Timer Mode.....	28
7.1.4.	Drying Program (Heating Pattern and Drying Temperature).....	28
7.1.5.	Measurement Unit	29
7.2.	Procedures to Store a Measurement Program.....	30
7.2.1.	Standard Drying	30
7.2.2.	Ramp Drying	33
7.2.3.	Step Drying	37

8.	Check Function	42
8.1.	Self-Check Function	42
8.1.1.	Operation	42
8.2.	Test Sample (Sodium Tartrate Dihydrate)	43
9.	Connecting to a Printer	44
9.1.	Print samples.....	45
9.1.1.	Example To Print The Whole Data At One Time.....	45
9.1.2.	Example To Print Selected Items.....	46
9.1.3.	Explanation for Print Item	48
10.	Connecting to a Computer	50
10.1.	RS-232C Serial Interface.....	51
10.2.	Output Format	52
10.3.	Command	53
11.	Data Memory Function	54
11.1.1.	Preparation	54
11.1.2.	Output All Data at One Time	55
11.1.3.	Delete All Data at One Time	55
12.	Calibration.....	56
12.1.	Identification Number (ID No.).....	56
12.1.1.	Setting the ID Number.....	56
12.2.	Calibration of the Weighting Sensor.....	57
12.2.1.	Operation	57
12.3.	Calibration of Drying Temperature (for MS-70 and MX-50).....	59
12.3.1.	Operation	59
13.	Function Table	61
13.1.1.	Operation	62
14.	Maintenance	63
14.1.	Cleaning the Heater Unit	63
14.2.	Replacement of the Halogen Lamp	64
14.3.	Factory Settings.....	65
14.3.1.	Operation	65
14.4.	Troubleshooting.....	66
14.5.	Error Message	67
15.	Specifications.....	68
15.1.	Dimensions	69
15.2.	Accessories and Peripheral Equipment.....	70
16.	Index	71



1. Safety and Compliance

WARNING

- ❑ Do not use a sample that could make a dangerous chemical reaction and cause an explosion or poisonous gas, when the sample is dried.
- ❑ Keep flammables away from the analyzer.
Parts of the analyzer become very hot. Materials placed near it might catch fire.
- ❑ Do not use the analyzer in ambient ignitable gas. It may cause explosion and fire.
- ❑ Use a power source (voltage, frequency, outlet type) adapted to the specification of the analyzer. If excessive voltage is used, the analyzer may overheat and be damage or cause a fire.
- ❑ Turn off the power switch and remove the power cord from the power outlet, when replacing the halogen lamp. Touching an electrode of the halogen lamp connector carelessly, it may cause to receive an electric shock.
- ❑ Do not disassemble the analyzer. It may cause an error, damage, receiving an electric shock or fire. If the analyzer needs service or repair, contact the local A&D dealer.
- ❑ Avoid getting the analyzer wet. It is not a water-resistant structure. If there is leakage of liquid into the analyzer, it may cause damage to the analyzer or receiving electric shock.
- ❑ Do not look at the active halogen lamp to protect your eyes from damage.
- ❑ Do not drop, hit or crack the glassware including the halogen lamp, to avoid an injury.
- ❑ When the halogen lamp is used beyond 5000 hours, we recommend replacing the lamp with a new one to avoid trouble.
- ❑ When discarding a halogen lamp, do not break it to avoid scattering glass and injury.

CAUTION

- ❑ Do not touch the heater cover, the halogen lamp, glass-housing, pan handle, sample pan and sample without adequate protection, it could cause a burn or scald. Parts of the analyzer are very hot when a measurement finishes. For operation, use the specified grips of the heater cover and pan handle. Use the standard accessory tools.
- ❑ Do not touch parts affixed with the mark, because they may get very hot and dangerous.
- ❑ When the analyzer is used in a room where hot air does not diffuse, it may unexpectedly overheat. In this case, adjust the drying temperature or move the analyzer to a place with adequate ventilation.
- ❑ Avoid leaving the analyzer in direct sunlight, as that could cause discoloration of the case or a malfunction.

Compliance with FCC Rules

Please note that this device generates, uses and can radiate radio frequency energy. This device has been tested and has been found to comply with the limits of a Class A computing device pursuant to Subpart J of Part 15 of FCC rules. These rules are designed to provide reasonable protection against interference when this device is operated in a commercial environment. If this unit is operated in a residential area, it may cause some interference and under these circumstances the user would be required to take, at his own expense, whatever measures are necessary to eliminate the interference.

(FCC = Federal Communications Commission in the U.S.A.)

Compliance with Council Directives

CE This device features radio interference suppression and safety regulation in compliance with the following Council Directives

Council directive 89/336/EEC	EN61326	EMC directive
Council directive 73/23/EEC	EN61010-1	Low voltage directive



EN61326 Emission and Immunity.



A&D Instruments Ltd
24 Blacklands Way
Abingdon Business Park
Abingdon, Oxfordshire
OX14 1DY United Kingdom
Tel: +44 (0)1235 550420
Fax: +44 (0)1235 550485
email: info@aandd-eu.net
Internet: http://www.aandd-eu.net
Vat No: GB 596 1273 15



A & D Instruments Ltd. hereby declare that the following weighing product conforms to the requirements of the council directives on ...

Electromagnetic Compatibility (EMC) 89/336/EEC
Low voltage equipment (LVD) 73/23/EEC amended by 93/68/EEC

provided that they bear the CE mark of conformity as shown above.

MF, ML, MX and MS Series Moisture Analyser

Standards applicable :

BS EN 61326 Electrical equipment for measurement, control and laboratory use - EMC requirements

BS EN 61010 Safety requirements for electrical equipment for measurement, control and laboratory use.

CE Mark First Applied May 2002

Signed for A&D Instruments in Oxford England April 2005

Takeo Goto
Managing Director

... Clearly a Better Value



Registered in England No: 2609110 – Registered Office: 24 /26 Blacklands Way Abingdon Oxon OX14 1DY



2. Precautions



2.1. Installing the Analyzer

---Caution for Measurement Safety ---

- ❑ Do not install the analyzer in a dangerous place.
- ❑ Maintain the following ambient condition to operate the analyzer.
5°C to 40°C (41°F to 104°F), 85%RH or less (no condensation)
- ❑ Keep flammables away from the analyzer.
- ❑ Do not put anything on the heater cover.
- ❑ Do not install the analyzer in a small airtight room. If the analyzer is used in an airtight room, hot air does not diffuse, the sample may unexpectedly overheat. In this case, the safety circuit of the halogen lamp activates. Move the analyzer to a place with adequate ventilation or adjust the drying temperature.
- ❑ There is the voltage label on the back panel of the analyzer.
Confirm that voltage, frequency and outlet type is correct for your local voltage.
- ❑ Confirm that the rated voltage of the halogen lamp is correct for your power supply voltage. (Refer to 14.4.Troubleshooting)

Voltage Label	Power Supply Voltage	The Rated Voltage of Halogen Lamp
100 - 120 V	AC 100 V to AC 120 V	AC 120 V
200 - 240 V	AC 200V to AC 240 V	AC 240 V

- ❑ Ground the analyzer using the ground terminal of the power cord.
- ❑ Do not change the setting of the I/II switch on the rear of the analyzer. If the incorrect setting is used, it may damage the analyzer or cause a fire.

---Caution for Precision Measurement---

Confirm the following condition, because the weighing sensor (S.H.S.) is very sensitive.

- ❑ The weighing surface should be solid and free from vibration, drafts and as level as possible.
- ❑ Install the analyzer in a stable place avoiding vibration and shock.
- ❑ Install the analyzer where it not affected by heaters or air conditioners.
- ❑ Ensure a stable power source.
- ❑ Keep the analyzer away from equipment that generates magnetic fields.
- ❑ Discharge static electricity.



2.2. During Use

---Caution for Measurement Safety ---

Operate the analyzer using the following procedure.

- ❑ Put the sample pan in the correct position.
- ❑ Handle the grip of the heater cover to open and close it.
- ❑ Use the pan handle to move the sample pan.
- ❑ Do not touch hot parts around the glass-housing, when the cover is opened.
- ❑ The glass-housing is very hot. It may cause a burn, if touched.
- ❑ The sample pan and pan handle is very hot, when finishing measurement. Allow them cool down.
- ❑ Use the tweezers or spoon to move the sample.

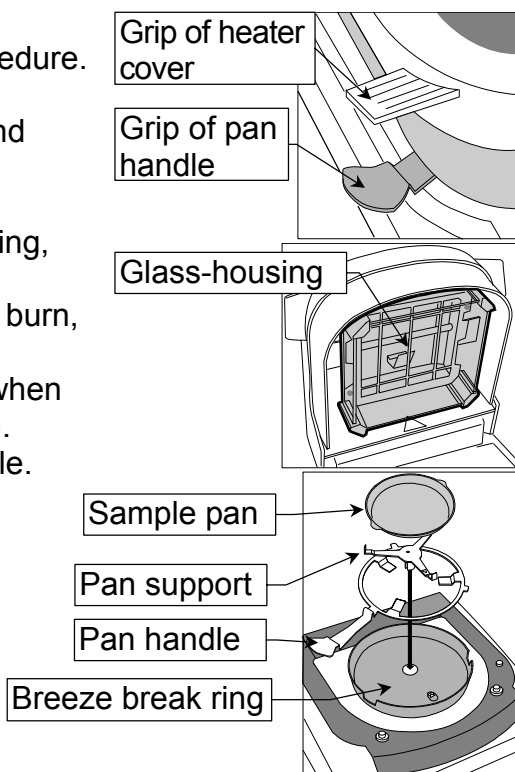
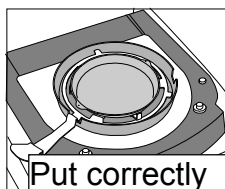

Grips and Hot Parts.

- ❑ Hot parts are as follows:
Use the following grips to operate the analyzer.

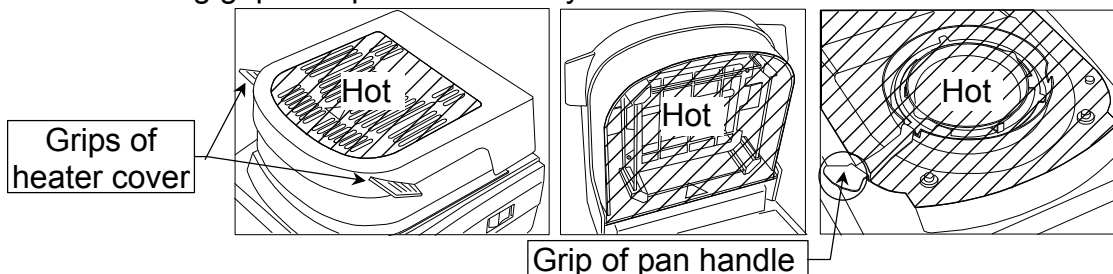

Do Not Measure a Dangerous Sample.

- ❑ Do not use an explosive, flammable or noxious substance as a sample.
Do not use a sample that makes a dangerous substance by drying it.
Do not use unknown substances.
- ❑ When a sample surface becomes dry first and the inner pressure increases, the sample may explode. Do not use such a sample.
- ❑ Turn off the power switch if a sample catches fire.
- ❑ The case of the analyzer is made of a flame-retardant substance (UL94V0).

Do Not Put any Flammable Matter Around the Analyzer.

- ❑ During and after measurement, parts of the analyzer become very hot. Do not put flammable matter near the analyzer.
- ❑ Do not put any thing on the heater cover.

Caution for Heating (Drying).

- When the drying temperature is set to 200°C and measurement is started, the thermostat of the halogen lamp may work after 30 minutes. When the halogen lamp has cooled down, the next measurement can be started. If necessary, change the drying time and temperature.
- When a measurement is started and the time passes one hour, the maximum temperature is automatically regulated to 160°C for safety.

Operation to Stop Measurement

- During measurement, the **STOP** key is always effective. If there is an error or danger, press the **STOP** key.



2.3. After Use and Maintaining the Analyzer

- Put dust cover on the analyzer after it is cool.
- Clean the glass-housing carefully.
- Clean fingerprints from the halogen lamp to keep its life. Refer to "14.2.Replacement of the Halogen Lamp".
- Avoid mechanical shock to the analyzer.
- Do not disassemble the analyzer.
- Protect the analyzer from excessive dust.
- Use the packing box (special container) to move the analyzer.
- Clean the analyzer with a lint free cloth that is moistened with warm water and a mild detergent.
- Do not use organic solvents to clean the analyzer.
- Do not disassemble or remodel the analyzer.

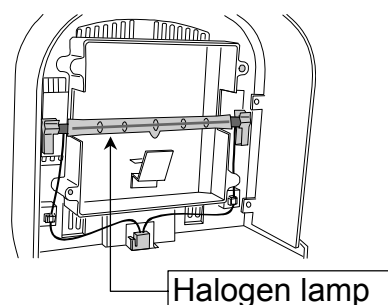
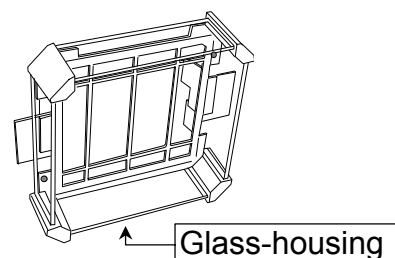
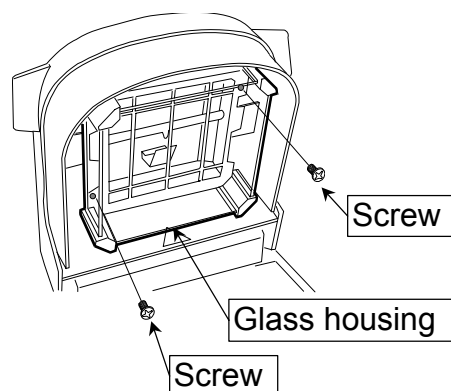



3. Outline and Features

- The moisture analyzer was designed using a **super hybrid sensor (S.H.S.)** adopted in an analytical balance. Therefore, the results are more precise and get greater repeatability.
- An analyzer using the S.H.S. has high sensitivity, needs only a sample quantity of a few grams, and the analysis time becomes shorter.
- A 400W halogen lamp is used as the heating source and the temperature on the sample pan can reach 200°C within two minutes.

- There are five analysis modes.

Standard mode The moisture content can be obtained with settings of the drying temperature and accuracy.

Quick mode Sample is heated up for approximately three minutes at 200°C so that analysis time becomes shorter. The moisture content can be obtained with settings of the drying temperature and accuracy.

Automatic mode..... When the change of moisture content per minute is less than the preset termination value, the measurement is automatically stopped and the result is obtained.

Timer mode The sample is dried for a preset time and the result is obtained.

Manual mode This mode can stop the measurement by key operation and the result is decided.

- The heating patterns can be used for analysis mode without using the quick mode. (For ML-50, standard drying and quick drying can be used only)

Standard drying..... Maintains a constant drying temperature.

Ramp drying Increases the drying temperature gently.

Step drying..... Uses multiple steps of the drying temperature.

Quick drying Heats up to 200°C for few minutes and uses a constant drying temperature.

- The analyzer can store and recall proper individual settings for each sample using a program number (PROG No.).

Maximum program number	MS-70 / MX-50	MF-50	ML-50
	20 sets	10 sets	5 sets

- The data memory function can store the results and output all of them at one time.

Maximum number of storable results	MS-70 / MX-50	MF-50	ML-50
	100	50	30

- The software, "WinCT-Moisture", a standard accessory for the MS-70 and MX-50, has a function that can make a graph of the change of moisture content in realtime and has an optimum temperature search program that judges heating at an appropriate temperature setting.

- The software, " WinCT", a standard accessory for the MF-50, is communication software for transmitting data to a computer using Microsoft Windows.

- The analyzer is equipped with a serial interface as standard. It can be connected to a printer or computer.
- The analyzer can calibrate the weighing sensor (Use special mass.) and drying temperature (Use temperature calibrator for MS-70 and MX-50 except MF-50 and ML-50). The analyzer can output the data required at GLP, GMP and ISO at the end of the calibration.
- The analyzer has a self check function that can detect function errors.
- The analyzer displays the current change of moisture content per minute [%/ min] in real-time. It can be used for the reference to find the analyzing mode.
- The sample pans can be used repeatedly.
The sample pans and the disposable aluminum foil pans are included in the standard accessories.
- There is a test sample that is used to check the moisture accuracy. (The test sample is a part of the standard accessories except for the ML-50)
- The glass fiber sheets can be used for quick and precise measurement of a liquid sample. (The glass fiber sheets are a part of the standard accessories except for the ML-50)
- A reference card is built into the bottom of the analyzer.

Principle and Use

- The moisture analyzer, based on the principle of thermogravimetric analysis, dries a sample using a halogen lamp and obtains the moisture content in % and other results by the difference between the wet weight and dry weight.



4. Packing List and Names of each part

- Keep the packing box to move the analyzer.
- Packing list as follows:

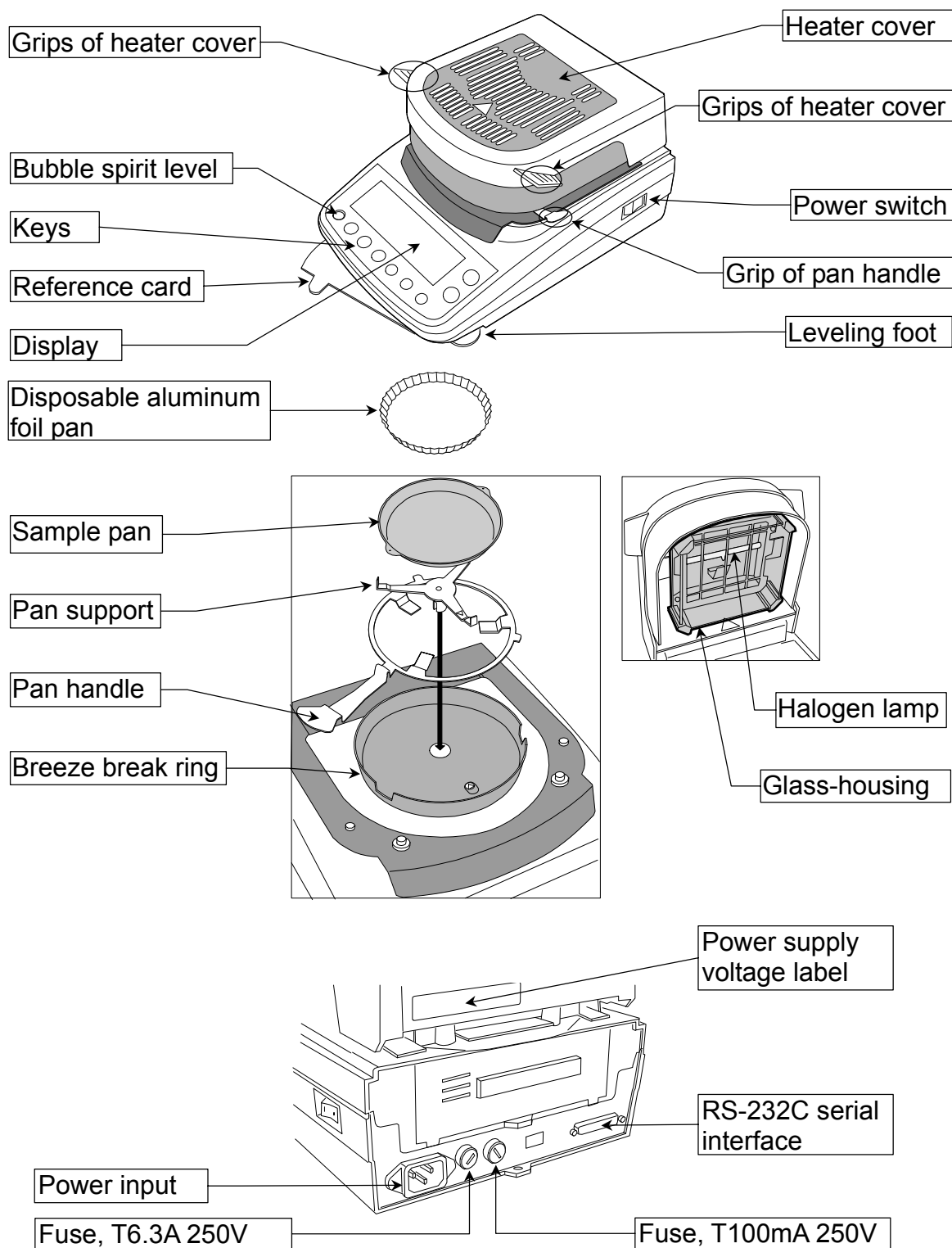

Caution

Please confirm that the analyzer is correct for your local voltage, receptacle type and the power cord.

Accessory Name

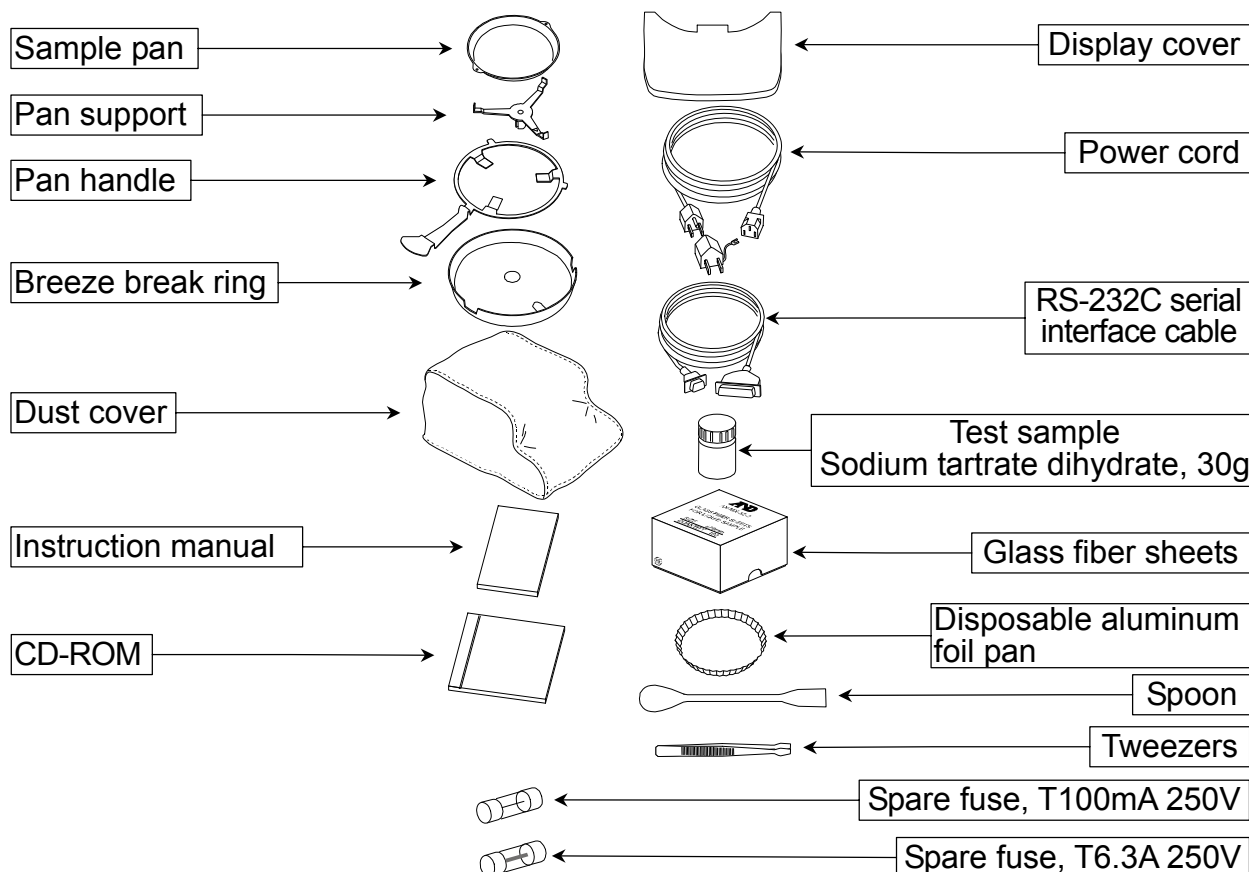

Accessory List

O : Standard accessory, — : Accessory by your order.

	MS-70	MX-50	MF-50	ML-50
Pan support	O	O	O	O
Breeze break ring	O	O	O	O
Display cover	O	O	O	O
Power cord	O	O	O	O
Spare fuse T100mA 250V	O	O	O	O
Spare fuse T6.3A 250V	O	O	O	O
Instruction manual	O	O	O	O
Dust cover	O	O	O	—
Test sample	O	O	O	—
Glass fiber sheets	O	O	O	—
Spoon	O	O	O	—
Tweezers	O	O	O	—
RS-232C serial interface cable	O	O	—	—
Sample pan	20	20	20	10
Pan handle	2	2	2	1
Disposable aluminum foil pan	100	100	100	100
CD-ROM *1	WinCT-Moisture	WinCT-Moisture	WinCT	—

*1: Application software for Windows.



4.1. Display and Keys

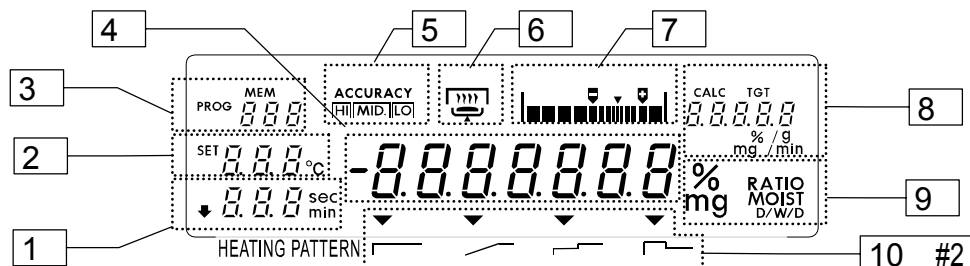

Name		State and Meaning	
1	Time	At gram display	Preset time is displayed at timer mode
		At measurement	Analysis time
2	Temperature of sample pan	At gram display	Set temperature of sample pan
		At measurement	Current temperature of sample pan
3	PROG: Program No.	At gram display	Program number of measurement program
	MEM: Data No.	Storing data	Data number of data memory function
	Analysis mode	At setting	Symbols: <i>Std, Quic, U-R, U-t, U-n</i>
4	Value	At gram display	Sample quantity [g]
		At measurement	Current moisture content [%]
5	Accuracy	Accuracy indicator of measurement	
6		Indicator of heater cover, sample and drying process	
		Sample needs at least 0.1 g or more to start measurement.	
		Lights when heater cover is closed	
		Blinks during measurement. Disappears when not measuring	
7	Level indicator		Proper sample quantity range
			Reference of sample quantity for standard mode and quick mode.
8	Target quantity	At gram display	Standard mode Quick mode Automatic mode
		Target quantity of sample [g]	
		Preset termination value [%/min.]	
	Drying rate	At measurement	Current drying rate [%/min.]
9	Measurement unit		
	% MOIST /W	Moisture content is based on W	$\frac{W - D}{W} \times 100$
	% MOIST /D	Moisture content (Atro) is based on D	$\frac{W - D}{D} \times 100$
	% MOIST D/W	Dry content	$\frac{D}{W} \times 100$
	% MOIST W/D	Ratio	$\frac{W}{D} \times 100$
W: Wet sample mass D: Dried sample mass			
10	Heating pattern #1		
	Standard drying	Maintains a constant drying temperature.	
	Ramp drying	Increases the drying temperature gently.	
	Step drying	Uses multiple steps of the drying temperature.	
	Quick drying	Quick mode	





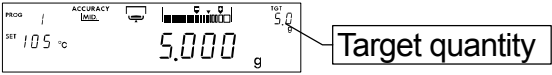
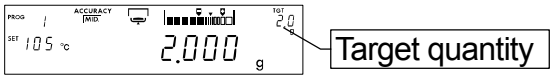
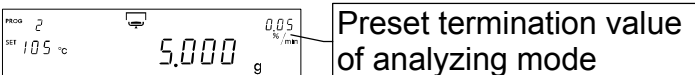
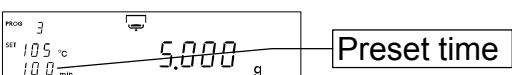
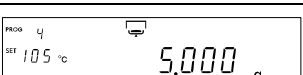

#1 ML-50 can select "standard drying " and "quick drying" only.

#2 ML-50 does not display "heating pattern".

Display Samples for Analysis Mode

Analysis mode	Symbols (during settings)	Gram display (after settings and before measurement)
Standard mode	<i>Std</i>	 Target quantity
Quick mode	<i>Quc</i>	 Target quantity
Automatic mode	<i>U-R</i>	 Preset termination value of analyzing mode
Timer mode	<i>U-t</i>	 Preset time
Manual mode	<i>U-n</i>	

Key Operation and Key Functions

Keys	Function and action
 PROGRAM	Stores or recalls measurement program with the program number during the gram display. Selects a heating pattern while the drying temperature is selected.
 SELECT	Selects item in the measurement program.
 ↓ , ↑	Changes value of item in the measurement program.
 ENTER	Stores current condition in the measurement program number. Output data at measurement.
 START	Start prepared measurement Sample needs at least 0.1 g or more to start measurement.
 STOP	Stop current measurement
 RESET	Sets the display to zero in the unit of gram. Cancel key.



5. Preparations



5.1. Installing the Analyzer

1. Select the place to install the analyzer.
Refer to "2.1.Installing the Analyzer".
2. Level the analyzer by adjusting the leveling feet and confirm it using the bubble spirit level.
3. Read the power supply voltage label on the back of the heater cover.

Confirm that voltage, frequency and outlet type is correct for your local voltage.
Confirm that the rated voltage of the halogen lamp is correct to your power supply voltage.

Voltage Label	Power Supply Voltage	The Rated Voltage of the Halogen Lamp
100 - 120 V	AC 100 V to AC 120 V	AC 120 V
200 - 240 V	AC 200V to AC 240 V	AC 240 V

4. Confirm that the power switch is set to the "OFF" position.
5. Connect the power cord. Ground the analyzer with the earth terminal on the power cord.
6. Align the guide hole of the breeze break ring to the guide on the body.
7. Install the pan support.
Align together the Δ signs on the pan support and body.
8. Put the sample pan on the pan handle.
And hook the pan handle on the notch in the rim of the breeze break ring.

Caution

For the disposable aluminum foil pan, place it on the sample pan.

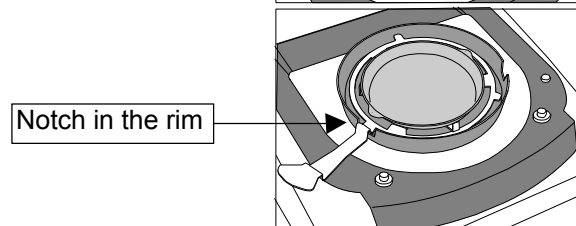
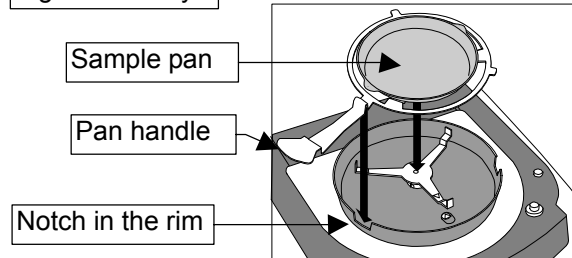
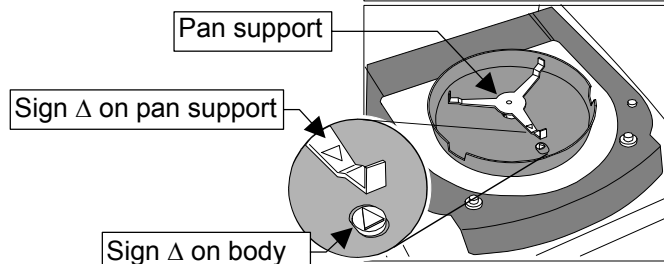
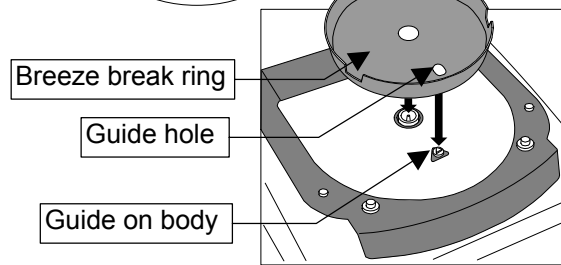
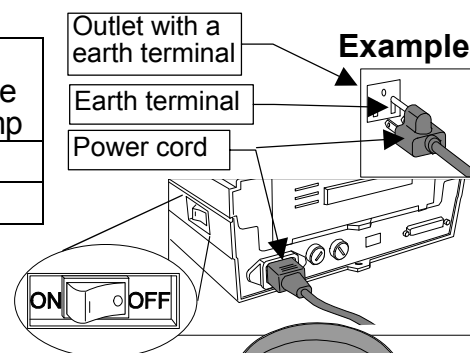
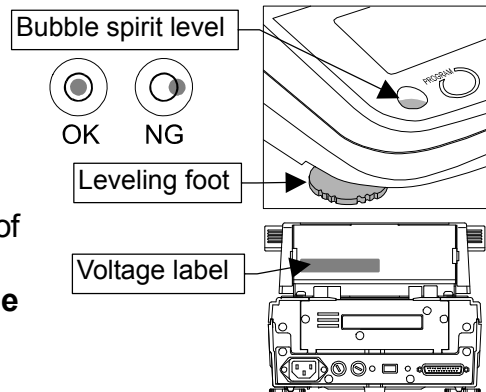



5.2. Setting the Clock and Calendar

Adjust the built-in clock and calendar before use.

5.2.1. Operation

1. Turn on the analyzer.
The gram unit (of weighing mode) is displayed.
2. Press and hold the **SELECT** key to display **CL Adj**.
3. Press the **ENTER** key to display the calendar.
Example: 15th April, 2002
4. To skip the calendar settings.
Press the **↓** or **↑** key to proceed step 5.
To adjust the calendar settings.
Press **SELECT** key. Adjust the calendar using the following keys.

- SELECT** keySelects a figure.
- ↓, ↑** keySelects a value for the figure.
- ENTER** keyStores the current date and proceeds to step 5.
- RESET** keyCancels the adjustment and proceeds to step 5.

Symbols and arrangement of the calendar

- ynd*Year, month, day
- ndy*Month, day, year
- dny*Day, month, year

The arrangement of the calendar is used for the report of GLP, GMP and ISO.

5. Time is displayed.
 6. To finish the adjustment.
Press the **RESET** key to proceed step 7.
To adjust the clock.
Press the **SELECT** key. Adjust the clock using the following keys.
- SELECT** keySelects a figure.
 - ↓, ↑** keySelects a value for the figure.
 - ENTER** keyStores time and proceeds to step 7.
 - RESET** keyCancels the adjustment and proceeds to step 7.
7. When finishing the adjustment, **dP** is displayed.
Press the **RESET** key to return to the weighing mode.

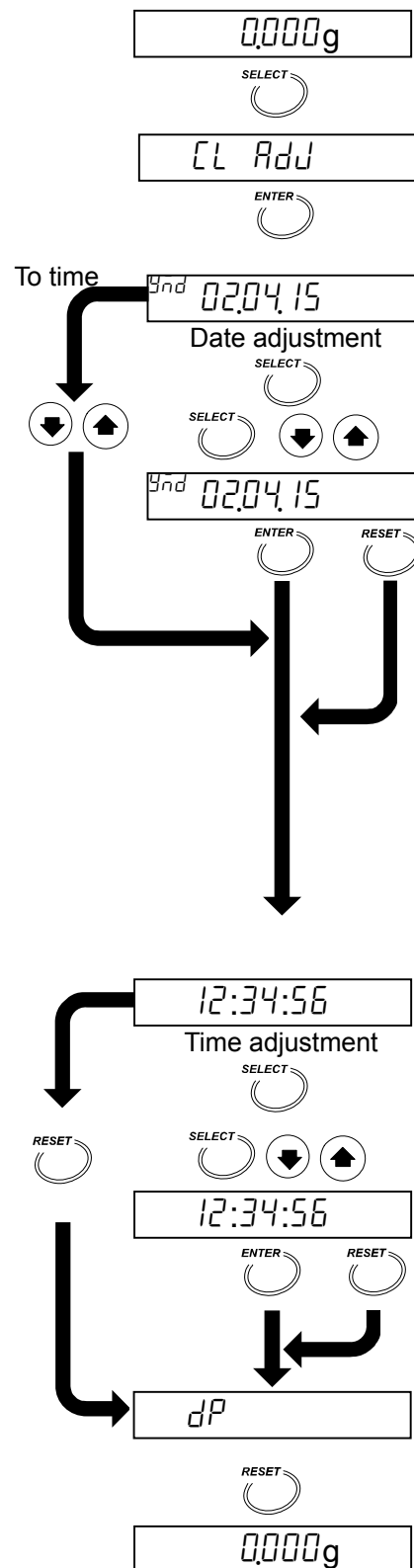



5.3. Proper Operation for Precision Measurement

5.3.1. Operation of the sample

- Use a proper sample quantity. If the quantity is small, precise results may not be possible.
- If the moisture content of the sample (example: plastic) can be estimated that is less than 1%, the mass of moisture is not enough for the measurement, when measuring light sample, the result may not be accurate. Consider the following sample mass for the measurement.

An estimate of moisture content	1%	0.5%	0.1%
Necessary mass for measurement	2 g at least	5 g at least	20 g at least

- If the measurement is repeated, maintain the same sample quantity.
- Crush grain samples to a small, uniform powder for a quick drying process.
- Spread the sample as evenly as possible.
- The analyzer is designed to measure the moisture content of the sample by its weight change. If the sample includes volatile matter, it may vaporize during drying causing a measurement error.
- When measuring a liquid or liquid state sample that may make a film on the surface, we recommend you use a glass fiber sheet (AX-MX-32-2).

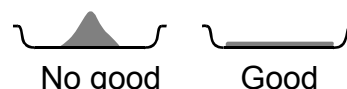

5.3.2. Operation of the analyzer

- Press the **RESET** key to display the zero value before each measurement.
- Check that the displayed sample weight is stable before measurement. Press the **START** key to start a measurement.
- Select the proper Analysis Mode to finish a measurement. Use the change of moisture content per one minute [%/min] that is displayed during measurement as a reference value.
- The analyzer needs a pre-heating process before measurement. When measuring samples repeatedly or continuously, the first result is always different from the others.
- The pre-heating process is as follows: Put a sample pan, instead of a sample, on the pan. Press the **START** key to heat it. The analyzer temperature becomes equilibrium.
- Use a sample on the sample pan that has cooled to room temperature. When a sample is put on a hot sample pan, the moisture content is diffused before measurement, and precise results are not possible. We recommend you use multiple sample pans.
- Do not pile up sample pans during a measurement.
- Avoid drift and vibration of air conditioners. It may cause "measurement error" and "unstable value". In particular, because MS-70 is sensitive instrument, it is necessary to consider these influences.
- When the difference between ambient temperature and sample temperature is small, it may cause temperature control error.
Example: If the heating temperature is crossed to the range of 30°C and 50°C, it is affected by a room temperature.
- Check the activation of the halogen lamp with the operation indicator.
Example: If low heating temperature is set, the brightness of halogen lamp becomes dark.

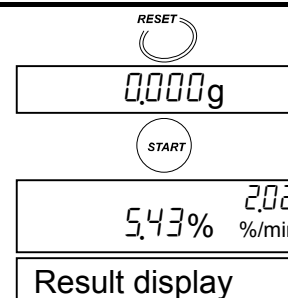

Check the activation with blinking

5.3.3. The Glass Fiber Sheets

- Use the glass fiber sheet to measure the moisture content that is included in the following samples. When this sheet is used, vaporization of moisture is speeded up and moisture measurement result becomes quick and precise.
- This accessory (AX-MX-32-1) is a package of 100 glass fiber sheets.
- This accessory is included in the packing for MS-70, MX-50 and MF-50.
- Purchase this accessory by your order for ML-50.
- Use the glass fiber sheet (AX-MX32-1) for high surface tension liquid sample.

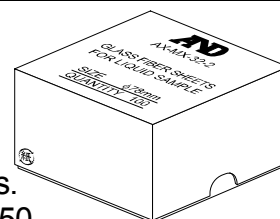

Example 1 : "Liquid Sample" Or "Meltable Sample"

When the glass fiber sheet is used for these measurements, moisture is more apt to vaporize because of expanding the surface area and space. And the glass fiber sheet has the effect of preventing a surface film from forming at drying process.

- A sample including a lot of moisture
: Milk, yogurt, soybean milk, condensed milk, ketchup, resin, liquid paste, hand soap, etc.
- A sample that melts and adheres to the sample pan.
Example:Chewing gums, caramel, hony, etc.

Procedure (Preparation before heating)

- 1 Put the glass fiber sheet on the sample pan.
- 2 Press the **RESET** key to display zero.
- 3 Soak the sample into the glass fiber sheet or put the sample on the glass fiber sheet.
- 4 Press the **START** key to start the measurement.

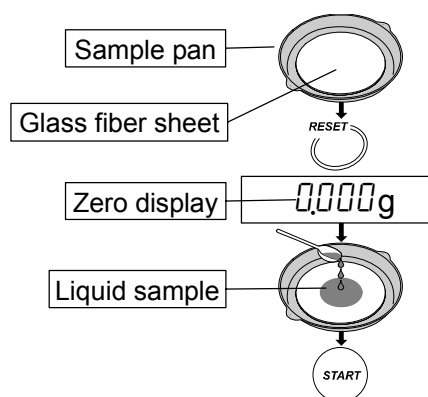

Example 2 : "If The Sample's Surface Is Apt To Carbonize"

When the sample is covered with a glass fiber sheet, carbonization of the sample surface decreases. Therefore the measurement result becomes repeatable and precise.

- A sample including a lot of sugar, protein and oil
Example:Hony, soybean powder, green tea leaves, cookies, etc.
- A sample that has dark surface and is apt to carbonize
Example:Coffee, peanuts, etc.

Procedure (Preparation before heating)

- 1 Put a glass fiber sheet on the sample pan.
- 2 Press the **RESET** key to display zero.
- 3 Remove the glass fiber sheet.
- 4 Put the sample on the pan.
Cover the sample with the glass fiber sheet.
- 5 Press the **START** key to start the measurement.

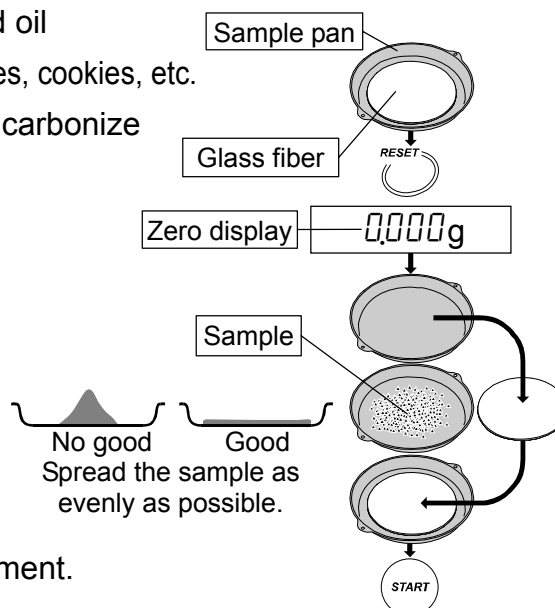



6. Measurement Procedure



6.1. Standard Mode Operation

The standard mode can obtain the moisture content with settings of ACCURACY and drying program (heating pattern, drying temperature).

6.1.1. ACCURACY

ACCURACY of measurement can be set either **HI**, **MID.** or **LO**.

The sample quantity is automatically selected by ACCURACY.

The termination value of the analyzing mode is automatically selected by ACCURACY and minimum scale value of % display.

The analysis mode is the program to finish the measurement when a change of moisture content per one minute becomes smaller than a preset termination value.

The settings are as follows: Specify an ACCURACY.

			ACCURACY		
	Model	Minimum scale	HI	MID.	LO
Preset Termination value	MS-70	0.001 %	0.01 %/min	0.02 %/min	0.05 %/min
		0.01 %	0.02 %/min	0.05 %/min	0.10 %/min
		0.1 %	0.10 %/min	0.20 %/min	0.50 %/min
	MX-50	0.01 %	0.02 %/min	0.05 %/min	0.10 %/min
		0.1 %	0.10 %/min	0.20 %/min	0.50 %/min
	MF-50	0.05 %	0.05 %/min	0.10 %/min	
		0.1 %	0.10 %/min	0.20 %/min	
		1 %			
	ML-50	0.1 %	0.10 %/min	0.20 %/min	
		1 %			
Sample quantity			10 g	5 g	1 g
Use			Precise result	↔	Quick measurement

6.1.2. Operation

This operation explanation uses the following example of the MX-50: Refer to "7.Selection of Measurement Method" for detail.

Input Parameters

Analysis mode Standard mode
Drying temperature..... 130 °C
ACCURACY **LO**
Sample quantity..... Approximately 1 g (Automatic selection)
Analysis mode 0.10 %/min (Automatic selection)

Stored Parameters (Factory Settings for the MX-50)

Heating pattern Standard drying ()
Measurement unit..... Moisture content is based on a wet sample
Minimum scale value of % display..... 0.01 %
Minimum scale value of gram display... 0.001 g
Data memory function Not used

% MOIST /W

1. Turn on the analyzer.
The gram unit (of weighing mode) is displayed.



Enter the Standard Mode

2. Press the **SELECT** key to display an analysis mode and press the \downarrow or \uparrow key to select **Std**.

Standard mode

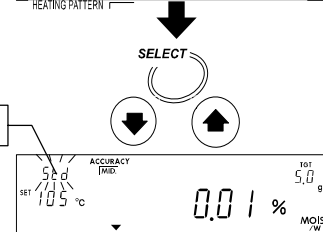

Select ACCURACY

3. Press the **SELECT** key to select ACCURACY.
When ACCURACY is selected, **HI**, **MID**, or **LO** blinks.
4. Press the \downarrow or \uparrow key to select **LO** of ACCURACY.

ACCURACY

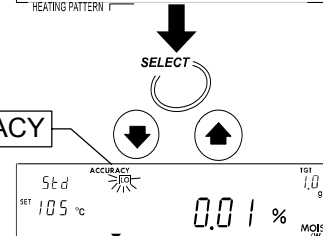

Standard drying ML-50 does not display

Set Drying Temperature at the Sample Pan

5. Press the **SELECT** key to select the drying temperature.
6. Press the \downarrow or \uparrow key to set 130 °C.

Temperature

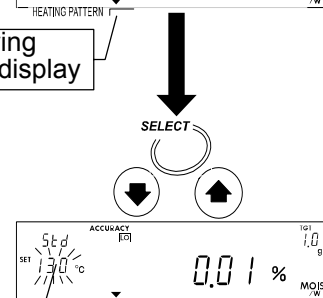

Store the Parameters and Finish the Operation

7. Press the **ENTER** key to store the parameters.
The weighing mode is automatically displayed.

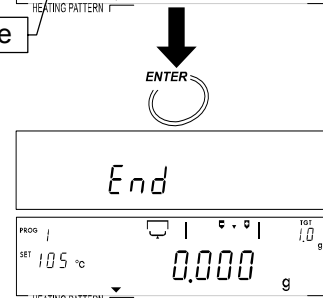

Put a Sample on the Pan

8. Put the breeze break ring, pan support, pan handle and sample pan in order. (With no sample.)
9. Close the heater cover.
10. When displaying a stable value, Press the **RESET** key. Avoid mechanical vibration, breeze and environmental noise during measurement. If it deviates from zero display, press the **RESET** key.

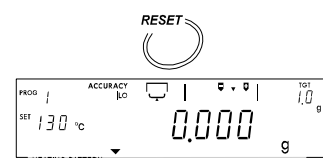
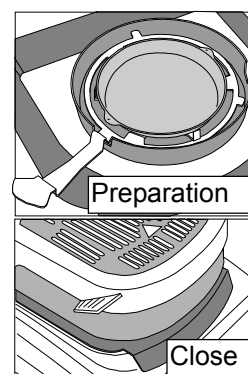

To next page

- Open the heater cover. Put in a sample using the level indicator.

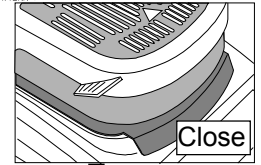
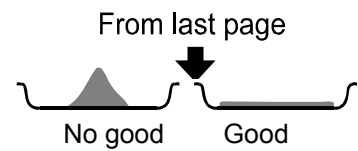
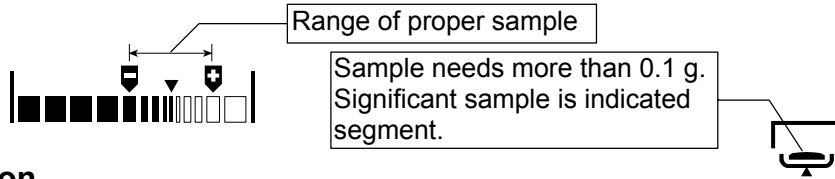

Caution

The sample needs to be more than 0.1 g. Spread the sample evenly.

- If the key is pressed during gram display, analysis mode, measurement unit and minimum scale value are displayed. If the key is pressed, the sample mass is output.

Start the Measurement

- Close the heater cover. Press the key after a stable value is displayed.

- If the key is pressed during measurement, other units can be displayed temporarily and its measurement values can be output.

Drying temperature

Drying rate

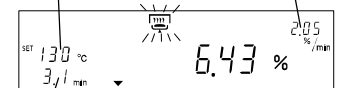

Analysis time

Caution

Do not press the key while sampling data.

Finish the Measurement

- When the change of moisture content per one minute (drying rate) reaches the preset termination value, the measurement is completed and the buzzer beeps.

Result

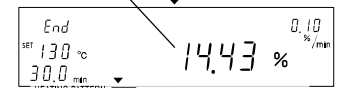

- Open the heater cover and remove the sample using the pan handle.

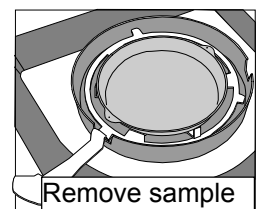

- Press the following key to return to gram display.
 - key.....Outputs (Prints) result.
 - keyReturns to the weighing mode.
 - key.....Returns to the weighing mode and displays zero.

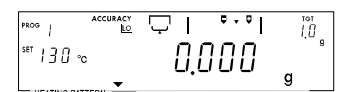

- If the same condition is used, proceed to step 8. If changing the condition, proceed to step 2.

The sample pans can be washed and reused.
There is the Reference card on the bottom of the analyzer.



6.2. Quick Mode Operation

The quick mode can obtain the moisture content with settings of ACCURACY and drying temperature.

Sample is heated up at 200°C for approximately three minutes so that moisture content is measured quickly.

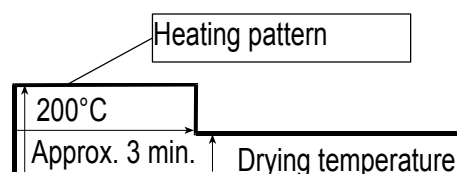

6.2.1. ACCURACY

ACCURACY of measurement can be set either **HI**, **MID.** or **LO**.

The sample quantity is automatically selected by ACCURACY.

The termination value of the analysis mode is automatically selected by ACCURACY and minimum scale value of % display.

Analysis mode is the program to finish the measurement when a change of moisture content per one minute becomes smaller than a preset termination value.

The settings are as follows: Specify an ACCURACY.

		ACCURACY			
	Model	Minimum scale	HI	MID.	LO
Preset Termination value	MS-70	0.001 %	0.02 %/min	0.05 %/min	0.05 %/min
		0.01 %	0.05 %/min	0.10 %/min	0.20 %/min
		0.1 %	0.10 %/min	0.20 %/min	0.50 %/min
	MX-50	0.01 %	0.05 %/min	0.10 %/min	0.20 %/min
		0.1 %	0.10 %/min	0.20 %/min	0.50 %/min
	MF-50	0.05 %	0.10 %/min	0.20 %/min	0.50 %/min
		0.1 %			
		1 %			
	ML-50	0.1 %	0.20 %/min	0.50 %/min	1.00 %/min
		1 %			
Sample quantity			5 g	2 g	1 g
Use			Precise result	↔	Quick measurement

6.2.2. Operation

This operation explanation uses the following example of the MX-50 :

Refer to "7.Selection of Measurement Method" for detail.

Input Parameters

Analysis mode Quick mode
 Heating pattern Quick drying (☐, Automatic selection)
 Drying temperature 130 °C
 ACCURACY **LO**
 Sample quantity Approximately 1 g (Automatic selection)
 Analyzing mode 0.20 %/min (Automatic selection)

Stored Parameters (Factory Settings for the MX-50)

Measurement unit Moisture content is based on a wet sample % MOIST /W
 Minimum scale value of % display 0.01 %
 Minimum scale value of gram display... 0.001 g
 Data memory function Not used

1. Turn on the analyzer.
The gram unit (of weighing mode) is displayed.

Enter the Quick Mode

2. Press the **SELECT** key to display an analysis mode and press the \downarrow or \uparrow key to select **QUC**.

Select ACCURACY

3. Press the **SELECT** key to select ACCURACY.
When ACCURACY is selected, **HI**, **MID**, or **LO** blinks.
4. Press the \downarrow or \uparrow key to select **LO** of ACCURACY.

Set Drying Temperature at the Sample Pan

5. Press the **SELECT** key to select the drying temperature.
6. Press the \downarrow or \uparrow key to set 130 °C.

Store Parameters and Finish the Operation

7. Press the **ENTER** key to store the parameters.
The weighing mode is automatically displayed.

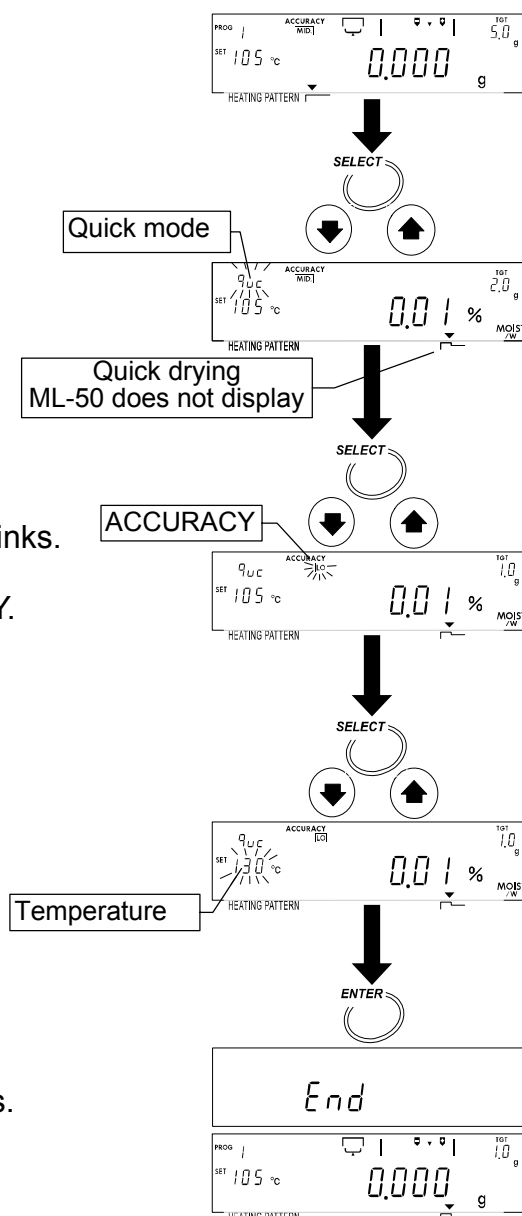

Put a Sample on the Pan

8. Put the breeze break ring, pan support, pan handle and sample pan in order. (With no sample.)
9. Close the heater cover.
10. When displaying a stable value, Press the **RESET** key.
Avoid mechanical vibration, breeze and environmental noise during measurement. If it deviates from zero display, press the **RESET** key.

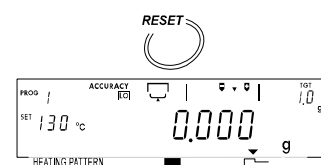
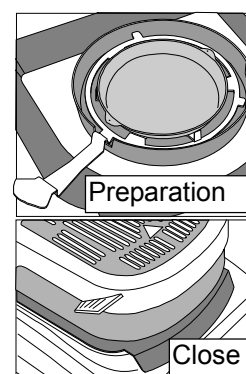

To next page

- Open the heater cover. Put in a sample using the level indicator.

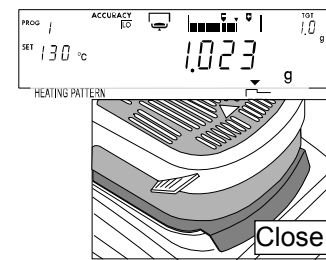
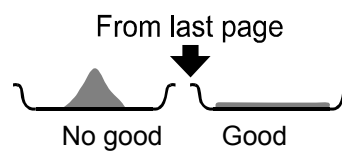
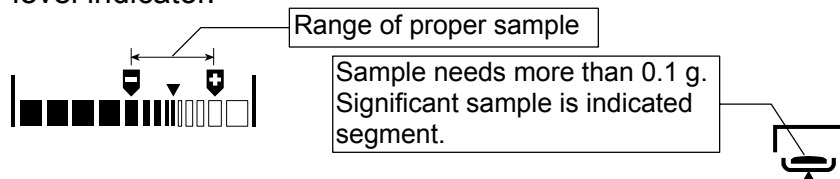

Caution

The sample needs to be more than 0.1 g.
Spread the sample evenly.

- If the key is pressed during gram display, analysis mode, measurement unit and minimum scale value are displayed. If the key is pressed, sample mass is output.

Start the Measurement

- Close the heater cover. Press the key after a stable value is displayed.
- If the key is pressed during measurement, other units can be displayed temporarily and its measurement values can be output.

Caution

Do not press the key while sampling data.

Drying temperature

Drying rate

Analysis time

Result

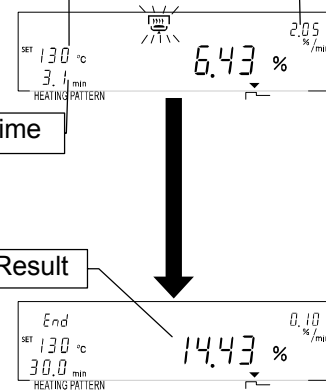

Finish the Measurement

- When the change of moisture content per one minute (drying rate) reaches the preset termination value, the measurement is completed and the buzzer beeps.
- Open the heater cover and remove the sample using the pan handle.
- Press the following key to return to gram display.
 - key.....Outputs (Prints) result.
 - keyReturns to the weighing mode.
 - key.....Returns to the weighing mode and displays zero.
- If the same condition is used, proceed to step 8. If changing the condition, proceed to step 2.

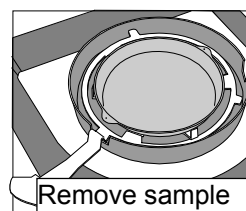

The sample pans can be washed and reused.
There is the Reference card on the bottom of the analyzer.

6.3. Program Number

The measurement conditions of all program numbers are set to the standard mode at the factory. The analyzer can store and recall proper individual settings for each sample with the program number (PROG No.).

MS-70 / MX-50	20 sets	PROG 1 to 20
MF-50	10 sets	PROG 1 to 10
ML-50	5 sets	PROG 1 to 5

The same measurement program is stored in all program numbers with factory settings.

Analysis mode.....	Standard mode
Heating pattern	Standard drying

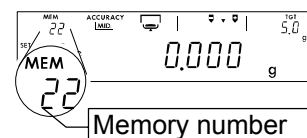
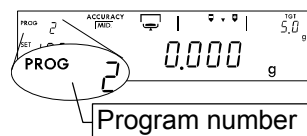

Caution If the data memory function is active, the data memory number (MEM) is displayed, in place of the program number (PROG).

6.3.1. Storing a Measurement Program to a Program Number

Displaying or recalling a PROG number, a measurement program can be renewed.

1. Press and hold the **PROGRAM** key in gram display.
2. Press the **↓** or **↑** key to select a program number
3. Press the **ENTER** key to use the selected number.
4. Press the **SELECT** key to edit the parameters.
5. Edit parameters of a measurement program.
Refer to "7.Selection of Measurement Method"
6. Press the following key to return to the gram display.
ENTER key.....Stores parameters to the selected number.
RESET key.....Cancels the operation and returns to the weighing mode.

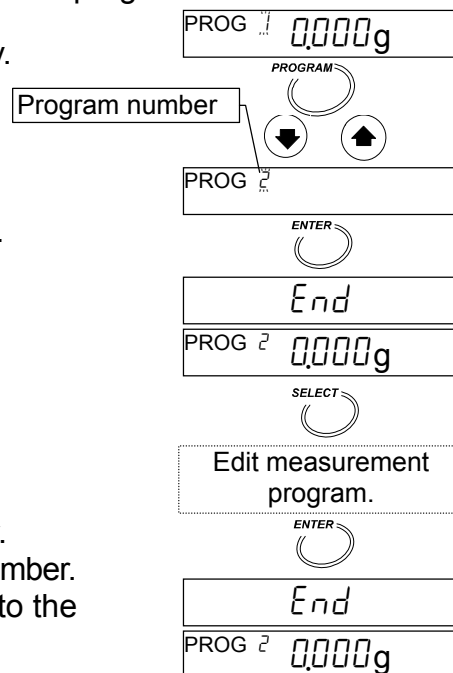

6.3.2. Recalling a Measurement Program with a Program Number

Stored measurement programs can be recalled with a program number.

1. Press and hold the **PROGRAM** key in the gram display.
2. Press the **↓** or **↑** key to select a program number
3. Press the **ENTER** key to use the selected number.

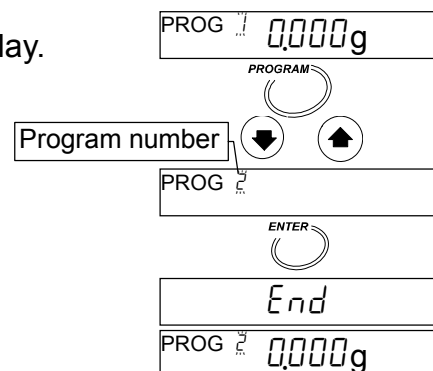



7. Measurement Programs



7.1. List of Measurement Programs

There are five analysis modes.

	Measurement Programs				
	Analyzing mode to Finish Measurement	Drying Program			
		Heating pattern		Drying Temperature	
		MS-70, MX-50, MF-50	ML-50	MS-70	MX-50 MF-50 ML-50
Standard Mode <i>Std</i>	Measurement condition is automatically selected by ACCURACY and minimum value of % display. When drying rate is less than preset termination value, measurement is completed automatically.	Standard drying Ramp drying Step drying	Standard drying	30°C to 200°C	50°C to 200°C
Quick Mode <i>Quc</i>		Quick drying			
Automatic Mode <i>U-R</i>	When drying rate is less than preset termination value, measurement is completed automatically.	Standard drying Ramp drying Step drying	Standard drying		
Timer Mode <i>U-t</i>	Sample is dried for a preset time. 1min. to 480min.				
Manual Mode <i>U-n</i>	Measurement is completed by the <input type="button" value="STOP"/> key. Max. 480 min.				

Drying rate: Change of moisture content per one minute [%/min]

7.1.1. ACCURACY of the Standard Mode and Quick Mode

ACCURACY of measurement can be set either HI, MID, or LO.

The sample quantity is automatically selected by ACCURACY.

The termination value of the analyzing mode is automatically selected by ACCURACY and minimum scale value of % display.

The analyzing mode is the program to finish the measurement when a change of moisture content per one minute becomes smaller than a preset termination value.

The settings are as follows: Specify an ACCURACY.

Drying rate: Change of moisture content per one minute [%/min]

Standard Mode

			ACCURACY		
	Model	Minimum scale	HI	MID.	LO
Preset Termination value	MS-70	0.001 %	0.01 %/min	0.02 %/min	0.05 %/min
		0.01 %	0.02 %/min	0.05 %/min	0.10 %/min
		0.1 %	0.10 %/min	0.20 %/min	0.50 %/min
	MX-50	0.01 %	0.02 %/min	0.05 %/min	0.10 %/min
		0.1 %	0.10 %/min	0.20 %/min	0.50 %/min
	MF-50	0.05 %	0.05 %/min	0.10 %/min	
		0.1 %	0.10 %/min	0.20 %/min	
		1 %			
	ML-50	0.1 %			
			1 %		
Sample quantity			10 g	5 g	1 g
Use			Precise result ↔ Quick measurement		

Quick Mode

			ACCURACY		
	Model	Minimum scale	HI	MID.	LO
Preset Termination value	MS-70	0.001 %	0.02 %/min	0.05 %/min	0.05 %/min
		0.01 %	0.05 %/min	0.10 %/min	0.20 %/min
		0.1 %	0.10 %/min	0.20 %/min	0.50 %/min
	MX-50	0.01 %	0.05 %/min	0.10 %/min	0.20 %/min
		0.1 %	0.10 %/min	0.20 %/min	0.50 %/min
	MF-50	0.05 %	0.10 %/min	0.20 %/min	0.50 %/min
		0.1 %			
		1 %			
	ML-50	0.1 %	0.20 %/min	0.50 %/min	1.00 %/min
		1 %			
Sample quantity			5 g	2 g	1 g
Use			Precise result ↔ Quick measurement		

7.1.2. Analyzing mode of the Automatic Mode

When the change of moisture content per one minute is less than the preset value, the measurement is automatically completed.

Preset Termination value to complete measurement	Range			
	MS-70	MX-50	MF-50	ML-50
2.00 %/min	↑	↑	↑	↑
1.00 %/min				
0.50 %/min			Available range	Available range
0.20 %/min		Available range	(Factory setting)	(Factory setting)
0.10 %/min	Available range	(Factory setting)		
0.05 %/min	(Factory setting)			
0.02 %/min				
0.01 %/min				
0.005 %/min				
0.002 %/min				
0.001 %/min				

Unavailable item

7.1.3. Analyzing mode of the Timer Mode

Sample is dried for a preset analysis time.

Drying Time 1 minute to 480 minutes.







Setting interval : 1 minute during 1 minute to 60 minutes.

5 minutes during 60 minutes to 480 minutes.

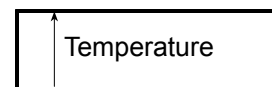
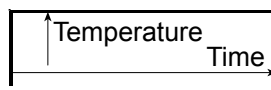
Factory setting: 10 minutes.

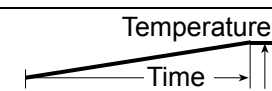
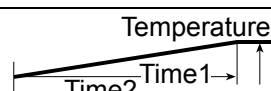
7.1.4. Drying Program (Heating Pattern and Drying Temperature)

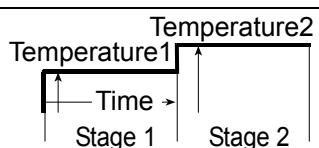
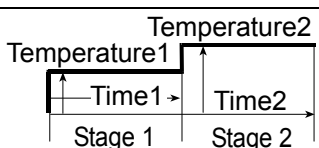
Heating pattern

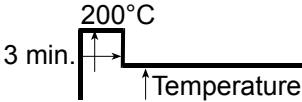
	Standard Mode, Automatic Mode, Manual Mode	Timer Mode	Quick Mode
Standard drying 			—
Ramp drying 			—
Step drying 			—
Quick drying 	—	—	

"Temperature 1" can be set higher than "temperature 2" in step drying.

ML-50, can select standard drying and quick drying only, does not display heating pattern.

How to Select quick mode (Extracts)

Press the **SELECT** key during the gram display.
 Display **quc** using the **↓** or **↑** key.
 ML-50 is does not display heating pattern.

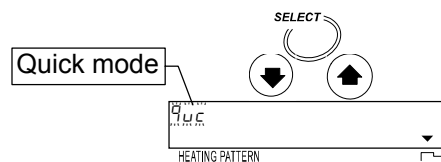

How to Select a Heating pattern without quick mode (Extracts)

Press the **SELECT** key to select temperature during the gram display.
 Press the **PROGRAM** key to select a symbol of heating pattern are displayed in order.
 ML-50 can select standard drying and quick drying only.

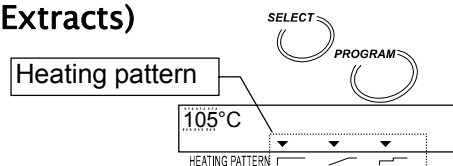

Display examples during settings

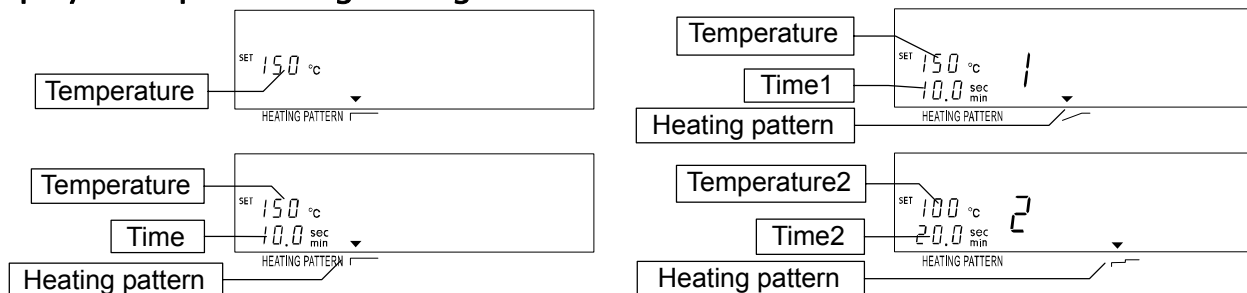

Drying Temperature at the Sample Pan

Drying temperature range for MS-70 30°C to 200°C, 1°C interval.
 Drying temperature range for MX-50, MF-50 and ML-50 50°C to 200°C, 1°C interval.
 When a measurement is started and one hour passes, the maximum temperature is automatically regulated to 160°C for safety.

7.1.5. Measurement Unit

Unit	Formula	Display
Moisture content is based on wet sample mass *1	$\frac{W - D}{W} \times 100$	% MOIST /W
Moisture content (Atr) is based on dried sample mass	$\frac{W - D}{D} \times 100$	% MOIST /D
Dry content	$\frac{D}{W} \times 100$	% RATIO D/W
Ratio *2	$\frac{W}{D} \times 100$	% RATIO W/D
Gram value	—	g

W: Wet sample mass D: Dried sample mass

*1: Factory settings

*2: When result reaches to 999%, measurement is stopped.



7.2. Procedures to Store a Measurement Program

7.2.1. Standard Drying

This explanation uses the following parameters and sample displays of MX-50.

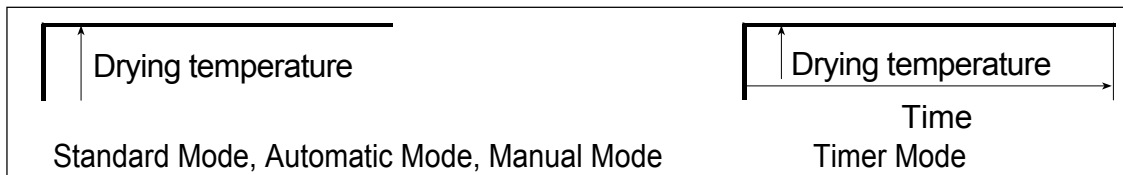

Common Items

Program number	2 (PROG 2)	
Drying program Heating pattern.....	Standard drying ()	
Drying temperature	160°C	
Measurement unit	Moisture content	
Minimum scale value during measurement ..	0.01 %	
Minimum scale value of gram display.....	0.001 g	
Sample quantity.....	Approximately 5 g	
Data memory function	Not used	

Items for Standard Mode

Analysis mode	Standard mode (Symbol:)
ACCURACY
Analyzing mode to finish a measurement.....	Automatic setting by ACCURACY

Items for Automatic Mode

Analysis mode	Automatic mode (Symbol:)
Analyzing mode to finish measurement.....	0.05 %/min

Items for Timer Mode

Analysis mode	Timer mode (Symbol:)
Analyzing mode to finish measurement.....	10 minutes

Items for Manual Mode

Analysis mode	Manual mode (Symbol:)
---------------------	-------------------------

1. Display the gram unit (of the weighing mode).

Select a Program Number to Edit the Measurement Program

2. Press the key and press the or key to select a program number.
3. Press the key to use the number.
4. The analyzer displays and returns to the weighing mode.

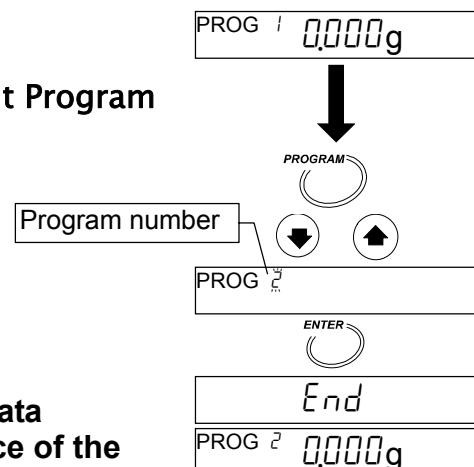

Caution If the data memory function is active, the data memory number (MEM) is displayed in place of the program number (PROG).

Select an Analysis Mode

- Press the **SELECT** key to select a symbol, it will blink. Select an analysis mode using the **↓** or **↑** key.
 If standard mode is used, select **Std**.
 If automatic mode is used, select **U-R**.
 If timer mode is used, select **U-t**.
 If manual mode is used, select **U-n**.

Set ACCURACY for the Standard Mode

- Select ACCURACY with the **SELECT** key.
 Select **MID** with the **↓** or **↑** key.
 When ACCURACY is selected, **HI**, **MID** or **LO** blinks.

Set the Heating Pattern

- Select drying temperature with the **SELECT** key.
 Select standard drying of the heating pattern with the **PROGRAM** key.

Set the Drying Temperature

- Set 160°C with the **↓** or **↑** key.

Set the Preset Termination Value for Automatic Mode

- Select the preset termination value with the **SELECT** key.
 Select 0.05 [%/min] with the **↓** or **↑** key.

Set the Analysis Time for the Timer Mode

- Select time with the **SELECT** key.
 Select 10.0 [min] with the **↓** or **↑** key.

Set the Measurement Unit

- Select a measurement unit with the **SELECT** key. Select a moisture content (based on a wet sample) with the **↓** or **↑** key.

Set the Minimum Scale Value of the % Display

- Select % display with the **SELECT** key.
 Select 0.01 [%] with the **↓** or **↑** key.

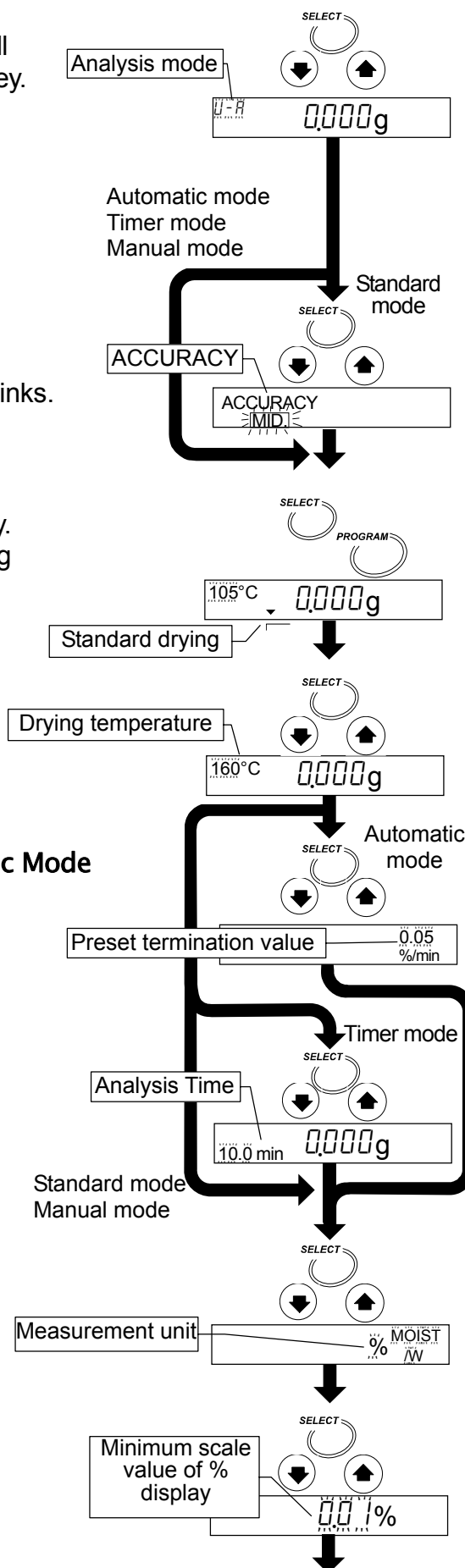

Set the Minimum Scale Value of the Gram Display

13. Select gram display with the **SELECT** key.
Select 0.001 [g] with the **↓** or **↑** key.

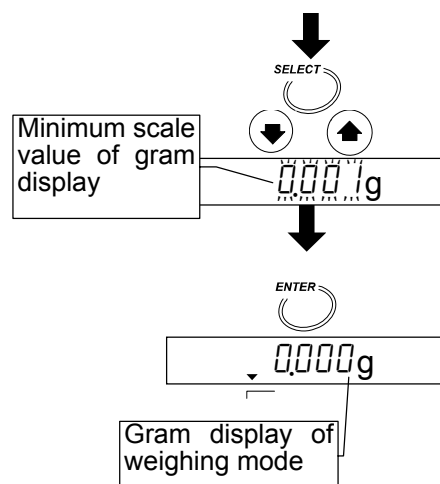

Store the Parameters and Finish the Operation

14. Press the **ENTER** key to store the new parameters for the measurement program to program number 2. Pressing the key, the weighing mode is automatically displayed. When PROG 2 is recalled, the settings can be used.

To cancel the new parameters and return to the weighing mode, press the **RESET** key.

7.2.2. Ramp Drying (ML-50 can not select ramp drying)

Standard Mode, Automatic Mode or Manual Mode

Refer to page 35 for Timer Mode

This explanation uses the following parameters and sample displays of MX-50.

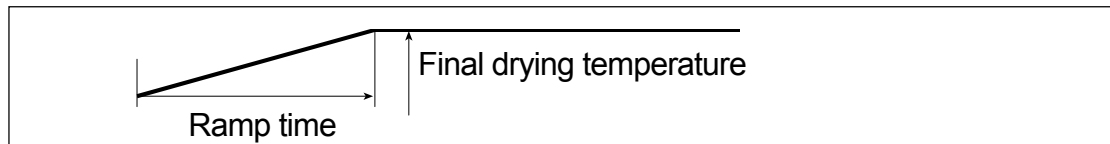

Common Items

Program number	3 (PROG 3)	
Drying program Heating pattern.....	Ramp drying ()	
Final drying temperature.....	160°C	
Ramp time.....	5.0 minutes	
Measurement Unit.....	Moisture content	<div style="border: 1px solid black; padding: 2px; display: inline-block;">% MOIST /W</div>
Minimum scale value during measurement ..	0.01 %	
Minimum scale value of gram display.....	0.001 g	
Sample quantity.....	Approximately 5 g	
Data memory function	Not used	

Items for Standard Mode

Analysis mode	Standard mode (Symbol: <div style="border: 1px solid black; padding: 2px;">Std</div>)
ACCURACY	<div style="border: 1px solid black; padding: 2px;">MID.</div>
Analyzing mode to finish measurement.....	Automatic setting by ACCURACY

Items for Automatic Mode

Analysis mode	Automatic mode (Symbol: <div style="border: 1px solid black; padding: 2px;">U-A</div>)
Analyzing mode to finish measurement.....	0.05 %/min

Items for Manual Mode

Analysis mode	Manual mode (Symbol: <div style="border: 1px solid black; padding: 2px;">U-n</div>)
---------------------	--

1. Display gram unit (of the weighing mode).

Select a Program Number to Edit the Measurement Program

2. Press the

PROGRAM

 key and press the or key to select a program number.
3. Press the

ENTER

 key to use the number.
4. The analyzer displays

End

 and returns to the weighing mode.

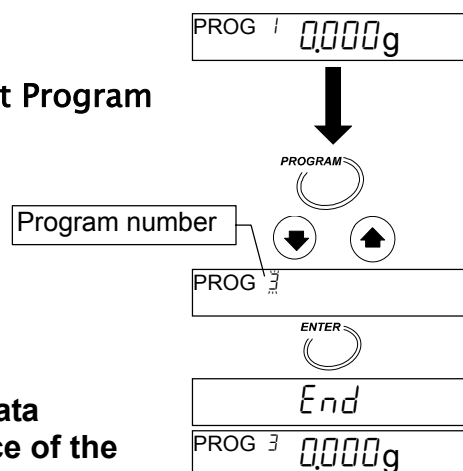

Caution If the data memory function is active, the data memory number (MEM) is displayed in place of the program number (PROG).

Select an Analysis Mode

5. Press the **[SELECT]** key to select a symbol, it will blink. Select an analysis mode using the **[↓]** or **[↑]** key.

If standard mode is used, select **[Std.]**.

If automatic mode is used, select **[U-R]**.

If manual mode is used, select **[U-n]**.

Set ACCURACY for Standard Mode

6. Select ACCURACY with the **[SELECT]** key.

Select **[MID.]** with the **[↓]** or **[↑]** key.

When ACCURACY is selected, **[HI]**, **[MID.]** or **[LO]** blinks.

Set the Heating Pattern

7. Select drying temperature with the **[SELECT]** key. Select ramp drying  of heating pattern with the **[PROGRAM]** key.

Set the Final Drying Temperature

8. Set 160°C with the **[↓]** or **[↑]** key.

Set the Ramp Time

9. Set 5.0 minutes with the **[↓]** or **[↑]** key.

Set the Preset Termination Value for Automatic Mode

10. Select preset termination value with the **[SELECT]** key. Select 0.05 [%/min] with the **[↓]** or **[↑]** key.

Set the Measurement Unit

11. Select measurement unit with the **[SELECT]** key. Select a moisture content (based on a wet sample) with the **[↓]** or **[↑]** key.

Set the Minimum Scale Value of the % Display

12. Select % display with the **[SELECT]** key. Select 0.01 [%] with the **[↓]** or **[↑]** key.

Set the Minimum Scale Value of the Gram Display

13. Select gram display with the **[SELECT]** key. Select 0.001 [g] with the **[↓]** or **[↑]** key.

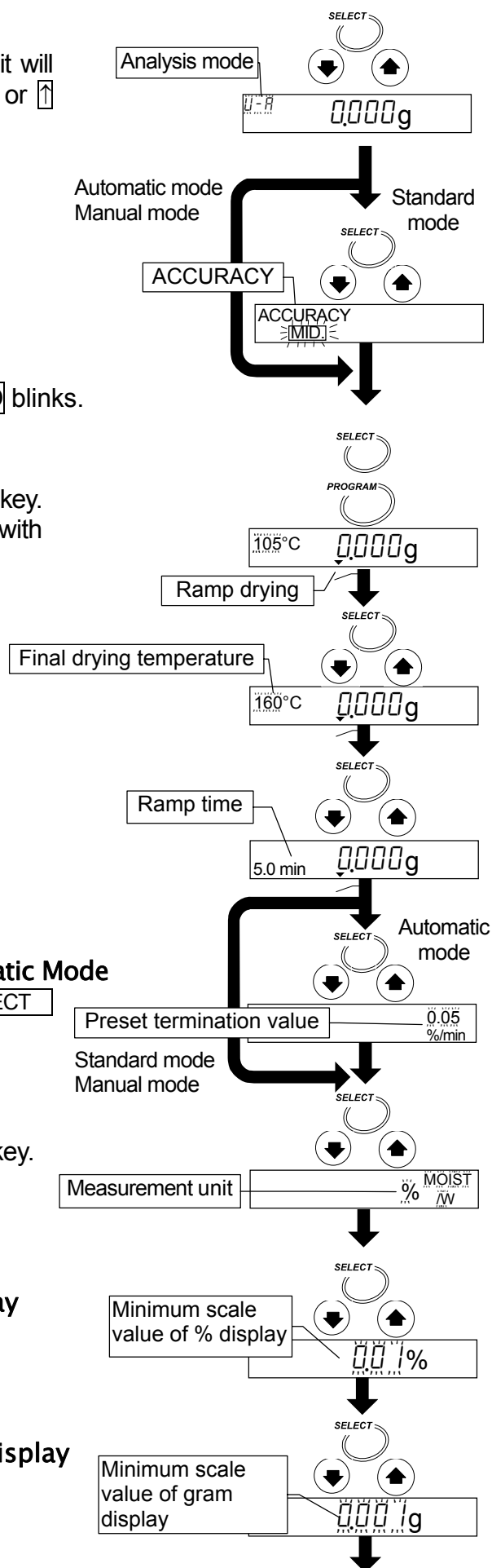

Store Parameters and Finish the Operation

- Press the **ENTER** key to store the new parameters of the measurement program to program number 3. Pressing the key, the weighing mode is automatically displayed. When PROG 3 is recalled, the settings can be used.

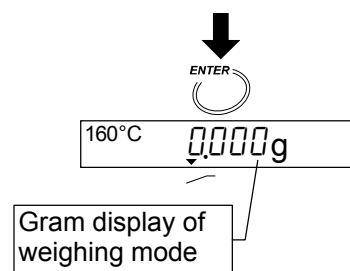

To cancel the new parameters and return to the weighing mode, press the **RESET** key.

Timer Mode

Refer to page 33 for Standard Mode, Automatic Mode or Manual Mode

This explanation uses the following parameters and sample displays of MX-50.

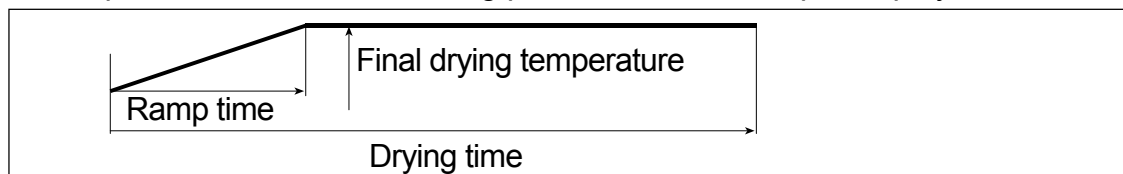

Common Items

Program number	4 (PROG 4)
Analysis mode	Timer mode (Symbol: U-t)
Drying program Heating pattern.....	Ramp drying ()
Final drying temperature.....	160°C
Ramp time.....	5.0 minutes
Drying time	10.0 minutes
Measurement unit.....	Moisture content % MOIST /W
Minimum scale value during measurement ..	0.01 %
Minimum scale value of gram display.....	0.001 g
Sample quantity.....	Approximately 5 g
Data memory function	Not used

- Display gram unit (of the weighing mode).

Select a Program Number to Edit the Measurement Program

- Press the **PROGRAM** key and press the **↓** or **↑** key to select a program number.
- Press the **ENTER** key to use the number.
- The analyzer displays **End** and returns to the weighing mode.

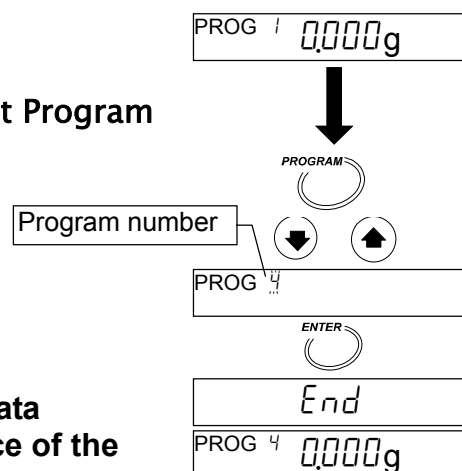

Caution If the data memory function is active, the data memory number (MEM) is displayed in place of the program number (PROG).

Select an Analysis Mode

5. Press the **SELECT** key to select a symbol, it will blink. Select **U-E** of the timer mode with the **↓** or **↑** key. (Press these keys to select it)

Set the Heating Pattern

6. Select drying temperature with the **SELECT** key. Select ramp drying  of the heating pattern with the **PROGRAM** key.

Set the Final Drying Temperature

7. Set 160°C with the **↓** or **↑** key.

Set the Ramp Time

8. Set 5.0 minutes with the **↓** or **↑** key.

Set the Analysis Time

9. Set 10.0 minutes with the **↓** or **↑** key.

Set a Measurement Unit

10. Select a measurement unit with the **SELECT** key. Select moisture content (based on a wet sample) with the **↓** or **↑** key.

Set the Minimum Scale Value of the % Display

11. Select the % display with the **SELECT** key. Select 0.01 [%] with the **↓** or **↑** key.

Set the Minimum Scale Value of the Gram Display

12. Select gram display with the **SELECT** key. Select 0.001 [g] with the **↓** or **↑** key.

Store the Parameters and Finish the Operation

13. Press the **ENTER** key to store the new parameters of the measurement program to program number 4. Pressing the key, the weighing mode is automatically displayed. When PROG 4 is recalled, the settings can be used. To cancel the new parameters and return to the weighing mode, press the **RESET** key.

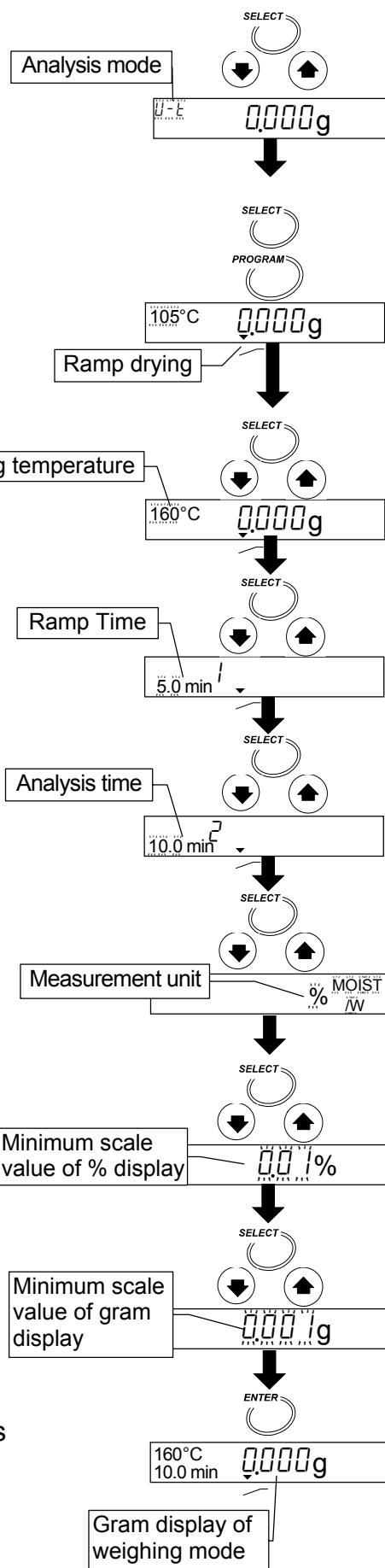

7.2.3. Step Drying (ML-50 can not select step drying)

Standard Mode, Automatic Mode or Manual Mode

Refer to page 39 for Timer Mode

This explanation uses the following parameters and sample displays of MX-50.

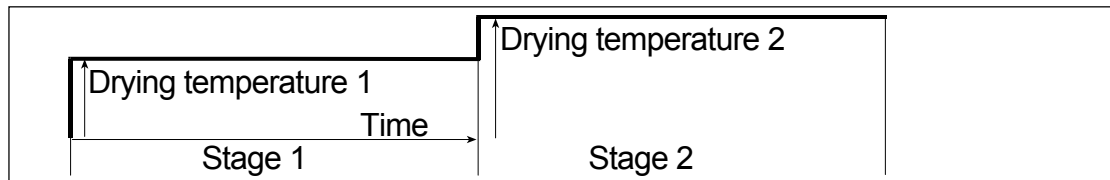

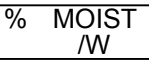

"Temperature 1" can be set higher than "temperature 2" in step drying.

Common Items

Program number	5 (PROG 5)	
Drying program Heating pattern.....	Step drying ()	
Drying temperature 1	120°C	
Drying temperature 2	160°C	
Time.....	5.0 minutes	
Measurement Unit.....	Moisture content	
Minimum scale value during measurement ..	0.01 %	
Minimum scale value of gram display	0.001 g	
Sample quantity.....	Approximately 5 g	
Data memory function	Not used	

Items for Standard Mode

Analysis mode	Standard mode (Symbol: )
ACCURACY	
Analyzing mode to finish measurement.....	Automatic setting by ACCURACY

Items for Automatic Mode





Analysis mode	Automatic mode (Symbol: )
Analyzing mode to finish measurement.....	0.05 %/min

Items for Manual Mode

Analysis mode	Manual mode (Symbol: )
---------------------	--

1. Display gram unit (of the weighing mode).

Select a Program Number to Edit the Measurement Program

2. Press the  key and press the  or  key to select a program number.
3. Press the  key to use the number.
4. The analyzer displays  and returns to the weighing mode.

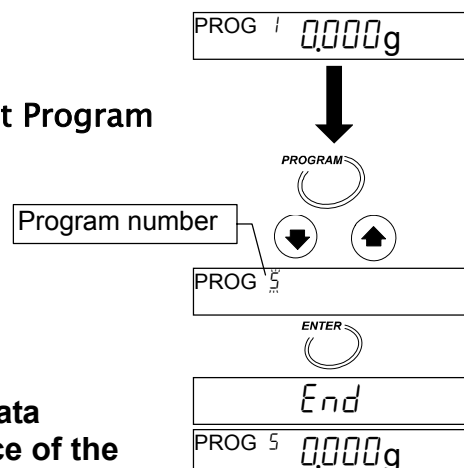

Caution If the data memory function is active, the data memory number (MEM) is displayed in place of the program number (PROG).

Select an Analysis Mode

- Press the **SELECT** key to blink a symbol, it will blink. Select an analysis mode using the **↓** or **↑** key.
If standard mode is used, select **Std**.
If automatic mode is used, select **U-R**.
If manual mode is used, select **U-n**.

Set ACCURACY for the Standard Mode

- Select **ACCURACY** with the **SELECT** key.
Select **MID** with the **↓** or **↑** key.
When **ACCURACY** is selected, **HI**, **MID**, or **LO** blinks.

Set the Heating Pattern

- Select drying temperature 1 with the **SELECT** key. Select step drying  of the heating pattern with the **PROGRAM** key.

Set Drying Temperature 1

- Set 120°C to drying temperature 1 with the **↓** or **↑** key.

Set the Time

- Select time with the **SELECT** key.
Set 5.0 minutes with the **↓** or **↑** key.

Set Drying Temperature 2

- Select drying Temperature 2 with the **SELECT** key.
Set 160°C with the **↓** or **↑** key.

Set the Preset Termination Value for Automatic Mode

- Select a preset termination value with the **SELECT** key. Select 0.05 [%/min] with the **↓** or **↑** key.

Set Measurement Unit

- Select measurement unit with the **SELECT** key.
Select moisture content (based on a wet sample) with the **↓** or **↑** key.

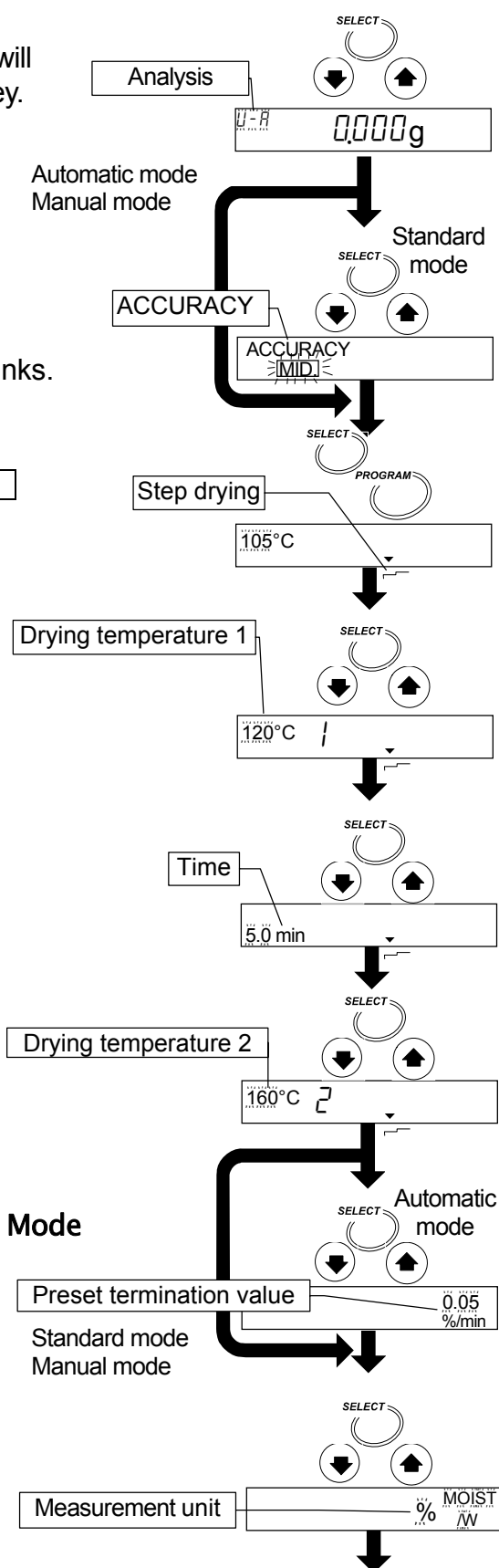

Set the Minimum Scale Value of the % Display

13. Select the % display with the **SELECT** key.
 Select 0.01 [%] with the **↓** or **↑** key.

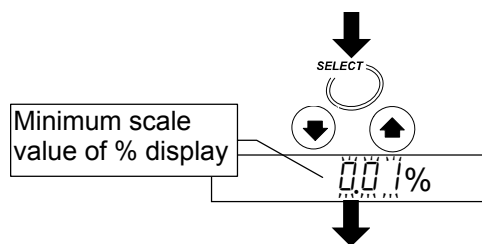

Set the Minimum Scale Value of the Gram Display

14. Select the gram display with the **SELECT** key.
 Select 0.001 [g] with the **↓** or **↑** key.

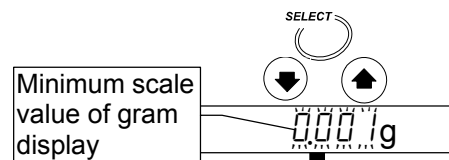

Store the Parameters and Finish the Operation

15. Press the **ENTER** key to store the new parameters of the measurement program to program number 3.
 Pressing the key, the weighing mode is automatically displayed.
 When PROG 3 is recalled, the settings can be used.

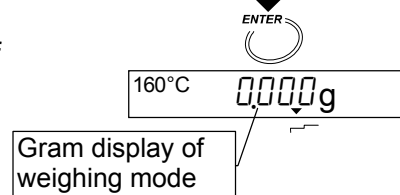

To cancel new parameters and return to weighing mode, press the **RESET** key.

Timer Mode

Refer to page 37 for Standard Mode, Automatic Mode or Manual Mode

This explanation uses the following parameters and sample displays of MX-50.

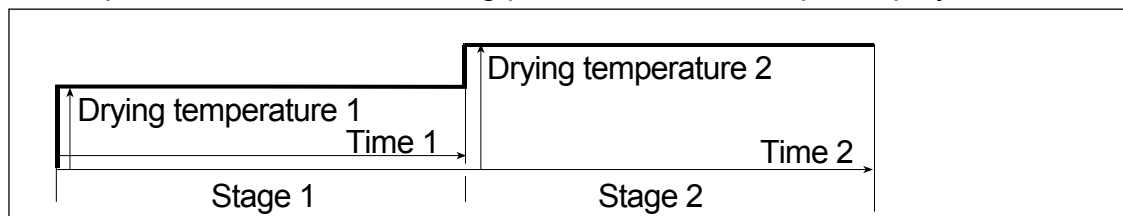

"Temperature 1" can be set higher than "temperature 2" in step drying.

Common Items

Program number	6 (PROG 6)	
Analysis mode	Timer mode (Symbol: U-t)	
Drying program	Heating pattern.....	Step drying ()
	Drying temperature 1	160°C
	Drying temperature 2	120°C
	Time 1.....	5.0 minutes
	Time 2.....	10.0 minutes
Measurement unit	Moisture content	% MOIST /W
Minimum scale value during measurement ..	0.01 %	
Minimum scale value of the gram display	0.001 g	
Sample quantity	Approximately 5 g	
Data memory function	Not used	

1. Display gram unit (of the weighing mode).

Select a Program Number to Edit the Measurement Program

2. Press the **PROGRAM** key and press the **↓** or **↑** key to select a program number.
3. Press the **ENTER** key to use the number.
4. The analyzer displays **End** and returns to the weighing mode.

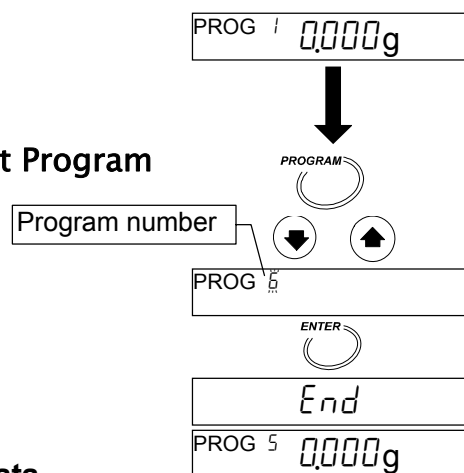

Caution If the data memory function is active, the data memory number (MEM) is displayed in place of the program number (PROG).

Select an Analysis Mode

5. Press the **SELECT** key to select a symbol, it will blink. Select **U-E** of the timer mode with the **↓** or **↑** key. (Press these keys to select it)

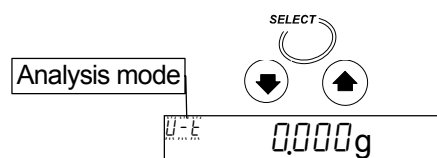

Set the Heating Pattern

6. Select drying temperature with the **SELECT** key. Select step drying of the heating pattern with the **PROGRAM** key.

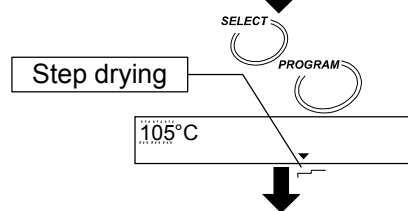

Set Drying Temperature 1

7. Set 120°C with the **↓** or **↑** key.

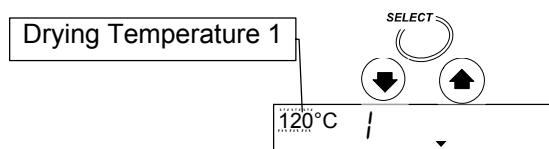

Set Time 1

8. Select time 1 with the **SELECT** key. Set 5.0 minutes with the **↓** or **↑** key.

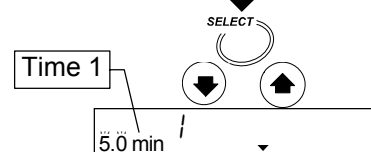

Set Drying Temperature 2

9. Select Drying Temperature 2 with the **SELECT** key. Set 160°C with the **↓** or **↑** key.

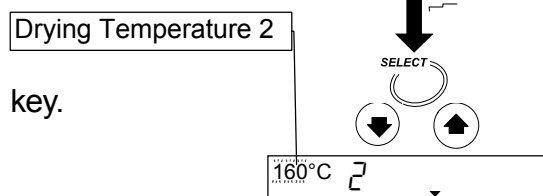

Set Time 2

10. Select time 2 with the **SELECT** key. Set 10.0 minutes with the **↓** or **↑** key.

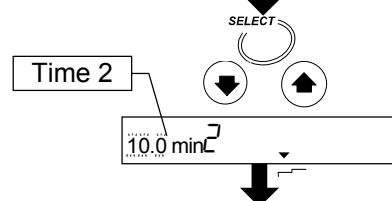

Set the Measurement Unit

11. Select measurement unit with the **SELECT** key.
Select the moisture content (based on wet sample) with the **↓** or **↑** key.

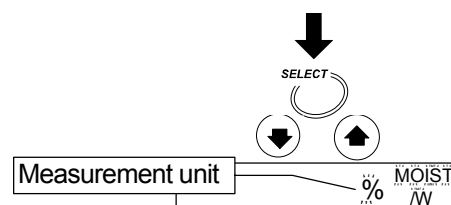

Set the Minimum Scale Value of the % Display

12. Select the % display with the **SELECT** key.
Select 0.01 [%] with the **↓** or **↑** key.

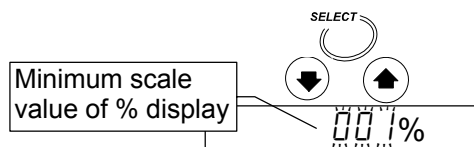

Set the Minimum Scale Value of the Gram Display

13. Select the gram display with the **SELECT** key.
Select 0.001 [g] with the **↓** or **↑** key.

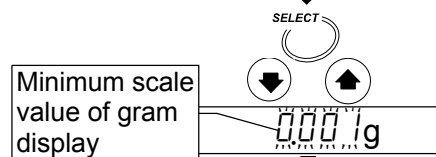

Store the Parameters and Finish the Operation

14. Press the **ENTER** key to store the new parameters of the measurement program to program number 6.
Pressing the key, the weighing mode is automatically displayed.
When PROG 6 is recalled, the settings can be used.

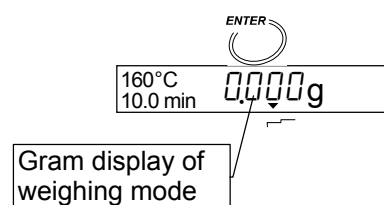

To cancel the new parameters and return to the weighing mode, press the **RESET** key.



8. Check Function



8.1. Self-Check Function

Use the self-check function to check whether there is an error or inaccurate result. During the check, the heater is turned on and the temperature sensor is checked.

Caution

Do not put flammable matter near the analyzer.

Do not put anything on the heater cover.

8.1.1. Operation

1. Display the gram unit (of the weighing mode).

0.000g

2. Press and hold the **PROGRAM** key to display **[CH]**.

Press and hold 

[CH]

3. Put the breeze break ring, pan support, pan handle and sample pan in order. (Do not put a sample on the pan.)

Close the heater cover.

Press the **ENTER** to start the check.

Do not put sample

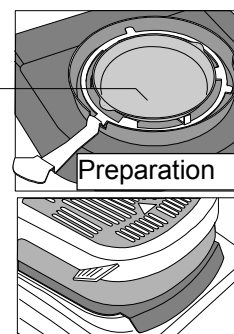

If **[CLOSE]** is displayed, the heater cover is not closed. When it is closed, the self-check function is started.

Checking



[CH] 

4. The check function needs approximately one minute.

Good result

[CH PASS]

Good result... Displays **[CH PASS]**, sounds buzzer and returns to weighing mode automatically.

Error The buzzer sounds and an error code is displayed. Refer to 14.5. Error Message for details.

Weighing mode

0.000g

Example: **[CH no]**

Error 0

HE Err



8.2. Test Sample (Sodium Tartrate Dihydrate)

---Test sample (Sodium tartrate dihydrate, $\text{Na}_2\text{C}_4\text{H}_4\text{O}_6 \cdot 2\text{H}_2\text{O}$)---

- Sodium tartrate dihydrate is used to check the accuracy of measurement for the analyzer.
As an ideal substance on theory, sodium tartrate dihydrate includes moisture content of 15.66% in the molecule. But the moisture content may change due to conditions of storage.
- The moisture content of 15.0 to 16.0% is obtained by the method below.
(Unit % is based on wet sample)
- Sodium tartrate is contained in food (example : wine). If it may irritate the eyes and nose, wash with water.
- The test sample can not be used repeatedly. Dispose of it as flammable matter.
- In case of MS-70 MX-50 and MF-50, test sample is included in these packing list.
In case of ML-50, purchase the test sample of accessory.

Caution A hot sample pan may cause an error. Allow the pan to cool before the next test.

Measurement

1. Enter the following parameters.

Analysis mode Standard mode (Symbol:)
 Drying program Heating pattern Standard drying ()
 Drying temperature 160°C
 ACCURACY
 Sample quantity Approximately 5 g is selected by
 ACCURACY automatically.
 Measurement unit Moisture content

2. Pre-heating process.

Put a sample pan, instead of a sample, on the pan.
Press the > key to heat it. The analyzer temperature becomes equilibrium.

3. Press the > key to make zero display.

Spread the sample as evenly as possible.

4. Press the > key to start the measurement.

The result is displayed after 8 minutes normally.
If the results is between 15.0 to 16.0%, the analyzer works properly.

5. Press the following key to complete the measurement.

> key Outputs (Prints) the results.
> key Returns to the weighing mode.
> key Returns to the weighing mode and displays zero.

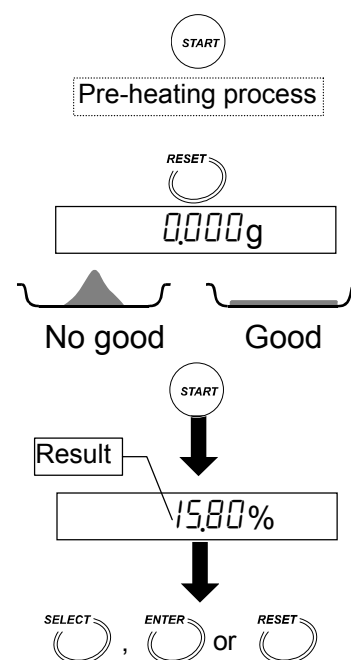



9. Connecting to a Printer

- The analyzer can be connected to a compact dot-matrix printer (AD-8121B) using the RS-232C interface. The results and record adapted to GLP, GMP and ISO can be printed.
 - GLP: Good Laboratory Practice,
 - GMP: Good Manufacture Practice,
 - ISO: International Organization for Standardization
- The statistical calculation data of the result and the graph data of the change of moisture content per one minute can be printed using the function of the AD-8121B.
- Use the AD-8121B accessory cable to connect them.

Setting List

Use	Analyzer settings				AD-8121B settings	Dip switch
	<i>Prt</i>	<i>S-d</i>	<i>PUSE</i>	<i>info</i>		
Result and easurement program(Excluding statistics calculation)	0,1	0	1	1,2	MODE 3 Dump printing	
Result with statistical calculation	0,1	0	0,1	0	MODE 1	
Trace of change of moisture content per one minute	2	0	0,1	0	MODE 2 Interval printing	
Data for GLP, GMP and ISO	0,1,2	0	0	1,2	MODE 3 Dump printing	

Refer to "13. Function Table" to detail of settings.
Read the instruction manual of the printer.

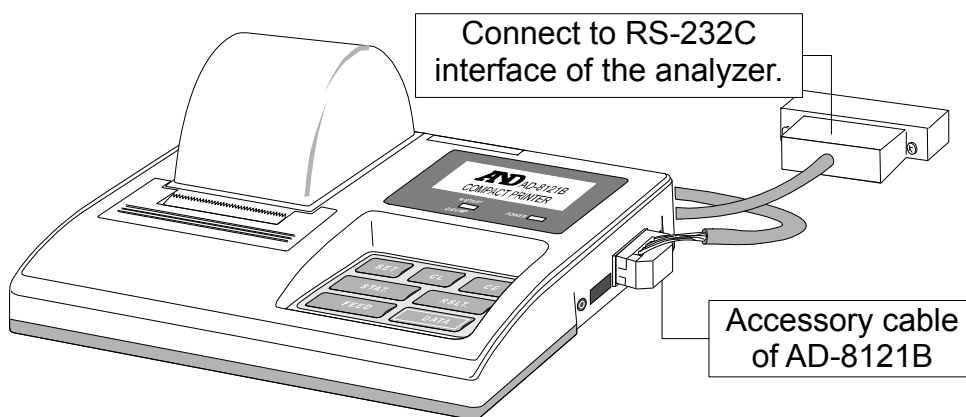

Compact dot-matrix printer (AD-8121B)



9.1. Print samples

9.1.1. Example To Print The Whole Data At One Time

This example is printed items of "analyzer information", "measurement program", "measurement data" and "signature space" at one time.

Preparation of Parameters

Device	Parameter	Description
Analyzer	<i>Prt 0</i> *1	When pressing the ENTER key, the result is outputted.
	<i>Prt 1</i>	Data is outputted after measurement automatically.
	<i>S-d 0</i> *1	Result is outputted only.
	<i>PUSE 1</i> *1	Approx. two seconds interval in each line.
	<i>info 1</i>	To print items at one time.
AD-8121B	MODE 3	Dump print (Received data is printed as it is)

*1: Factory settings

How To Print

Select a parameter to print "Measurement data". Refer to "13. Function Table"

<i>Prt 0</i>	When pressing the ENTER key, the result is outputted.
<i>Prt 1</i>	Data is outputted after measurement automatically.

Print Example

```

MODEL      A & D
           MX-50
S/N        P1234567
ID         LAB-123
PROGRAM    No. 1
MODE       STANDARD
           MID.
DRYING     STANDARD
           160 C
UNIT       MOIST/W
- - - - -
INITIAL WEIGHT
           5.678 g
FINAL WEIGHT
           4.567 g
RESULT     MOIST/W
           19.57 %
ANALYSIS TIME
           6.7min
DATE       2004/09/30
TIME       12:34:56
REMARKS
- - - - -
SIGNATURE
- - - - -

```

Factory
Product
Serial number
ID number. *2
PROG No.

} Analysis mode. Refer to 9.1.3

} Drying program. Refer to 9.1.3

Measurement Unit

} Wet weight

} Dried weight

} Measurement Result

} Analysis time

} Date. Refer to 9.1.3

} Remarks. Refer to 9.1.3

} Signature. Refer to 9.1.3

Analyzer information

Measurement program

Measurement data

Signature space

*2: ID number can be changed. Refer to "12.1. Identification Number (ID No.)"

9.1.2. Example To Print Selected Items

This print example is printed multiple measurement data and a suit of items specified from "analyzer information", "measurement program" or "signature space". When the title data is the same, it is economical use.

Preparation of Parameters

Device	Parameter	Description
Analyzer	<i>Pr</i> t 0 *1	When pressing the ENTER key, the result is outputted.
	<i>Pr</i> t 1	Data is outputted after measurement automatically.
	<i>S-d</i> 0 *1	Result is outputted only.
	<i>PUSE</i> 1 *1	Approx. two seconds interval in each line.
	<i>info</i> 2	To print specified item.
AD-8121B	MODE 3	Dump print (Received data is printed as it is)

*1: Factory settings

How To Print "Analyzer Information" and "Measurement Program"

1. Display the gram unit (of the weighing mode).
2. Press and hold the **ENTER** key.
3. Press the **SELECT** key to select **L 15t**.
4. Press the **ENTER** key to print them.
5. Display the gram unit (of the weighing mode).

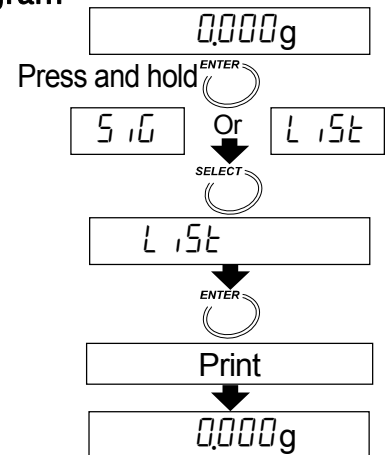

How To Print "Measurement Data"

Select a parameter to print "Measurement data". Refer to "13. Function Table"

<i>Pr</i> t 0	When pressing the ENTER key, the result is outputted.
<i>Pr</i> t 1	Data is outputted after measurement automatically.

How To Print "Signature Space"

1. Display the gram unit (of the weighing mode).
2. Press and hold the **ENTER** key.
3. Press the **SELECT** key to select **5.0g**.
4. Press the **ENTER** key to print "signature space".
5. Display the gram unit (of the weighing mode).

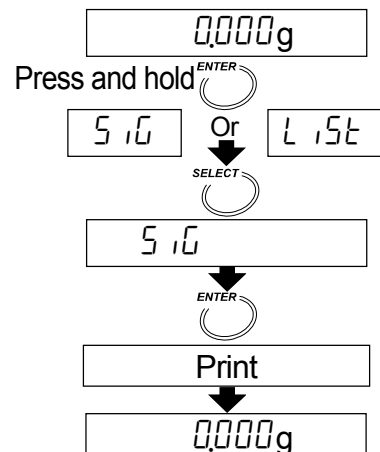

Print Example

MODEL	A & D	Factory	} Analyzer information
S/N	P1234567	Product	
ID	LAB-123	Serial number	
PROGRAM	No. 1	ID number. *1	
MODE	STANDARD	PROG No.	} Analysis mode. Refer to 9.1.3
	MID.		
DRYING	STANDARD		} Drying program. Refer to 9.1.3
	160 C		
UNIT	MOIST/ W	Measurement Unit	} Measurement program
	- - - - -		
INITIAL WEIGHT		Wet weight	} Measurement data
	5.678 g		
FINAL WEIGH		Dried weight	
	4.567 g		
RESULT	MOIST/ W	Measurement Result	
	19.57 %		
ANALYSIS TIME		Analysis time	
	6.7min		
DATE	2004/09/30	Date. Refer to 9.1.3	
TIME	12:34:56		
REMARKS		Remarks. Refer to 9.1.3	
	- - - - -		} Measurement data
INITIAL WEIGHT		Wet weight	
	5.791 g		
FINAL WEIGH		Dried weight	
	4.680 g		
RESULT	MOIST/ W	Measurement Result	
	19.19 %		
ANALYSIS TIME		Analysis time	
	7.8min		
DATE	2004/09/30	Date. Refer to 9.1.3	
TIME	12:57:12		
REMARKS		Remarks. Refer to 9.1.3	
	- - - - -		} Measurement data
INITIAL WEIGHT		Wet weight	
	5.432 g		
FINAL WEIGH		Dried weight	
	4.321 g		
RESULT	MOIST/ W	Measurement Result	
	20.45 %		
ANALYSIS TIME		Analysis time	
	5.4min		
DATE	2004/09/30	Date. Refer to 9.1.3	
TIME	13:24:57		
REMARKS		Remarks. Refer to 9.1.3	
	- - - - -		} Signature space
SIGNATURE		Signature. Refer to 9.1.3	

*1: ID number can be changed. Refer to "12.1. Identification Number (ID No.)"

9.1.3. Explanation for Print Item

"Analyzer information" and "Measurement program"

Analysis Mode	A Part of Print and Description	
Standard mode <i>Std</i>		<div style="display: flex; flex-direction: column; gap: 5px;"> <div>Standard mode</div> <div>ACCURACY HI, MID. or LO</div> </div>
Quick mode <i>Quc</i>		<div style="display: flex; flex-direction: column; gap: 5px;"> <div>Quick mode</div> <div>ACCURACY HI, MID. or LO</div> </div>
Automatic mode <i>U-A</i>		<div style="display: flex; flex-direction: column; gap: 5px;"> <div>Automatic mode</div> <div>Analyzing mode to finish measurement</div> </div>
Timer mode <i>U-t</i>		<div style="display: flex; flex-direction: column; gap: 5px;"> <div>Timer mode</div> <div>Analysis time</div> </div>
Manual mode <i>U-n</i>		<div style="display: flex; flex-direction: column; gap: 5px;"> <div>Manual mode</div> </div>

"Heating pattern"

Heating pattern	A Part of Print and Description	
Standard drying 		<div style="display: flex; flex-direction: column; gap: 5px;"> <div>Standard drying</div> <div>Drying temperature</div> </div>
Ramp drying 		<div style="display: flex; flex-direction: column; gap: 5px;"> <div>Ramp drying</div> <div>Final drying temperature</div> <div>Ramp time</div> </div>
Step drying 		<div style="display: flex; flex-direction: column; gap: 5px;"> <div>Step drying</div> <div>Drying temperature of stage 1</div> <div>Drying temperature of stage 2</div> <div>Time of stage 1</div> </div>
Quick drying 		<div style="display: flex; flex-direction: column; gap: 5px;"> <div>Quick drying</div> <div>Drying temperature</div> </div>

ML-50 can select standard drying and quick drying only.

"Measurement Unit"

Unit	A Part of Print	Formula	Display
Moisture content is based on wet sample mass *1	UNIT MOIST/ W	$\frac{W - D}{W} \times 100$	% MOIST /W
Moisture content (Atro) is based on dried sample mass	UNIT MOIST/ D	$\frac{W - D}{D} \times 100$	% MOIST /D
Dry content	UNIT RATIO D/W	$\frac{D}{W} \times 100$	% RATIO D/W
Ratio *2	UNIT RATIO W/D	$\frac{W}{D} \times 100$	% RATIO W/D
Gram value	UNIT g	—	g

W: Wet sample mass

D: Dried sample mass

*1: Factory settings

*2: When result reaches to 999%, measurement is stopped.

"Date"

It is printed date and time of the built-in clock in the analyzer.

Arrangement of the calendar is the same setting of the built-in clock.

Refer to ".5.2 Setting the Clock and Calendar "

If you need to adjust the clock, refer to ".5.2 Setting the Clock and Calendar "

```

DATE 2003/08/01
TIME 13:24:57
    
```

"Remarks Space"

For instance: This space can use for a comment about samples.

```

REMARKS
-----
    
```

"Signature Space"

```

SIGNATURE
-----
    
```



10. Connecting to a Computer

- The analyzer can be connected to personal computer using the RS-232C interface.
- The analyzer is the Data Communication Equipment type (DCE).
Use a straight-through type cable.
The MS-70 and MX-50 have the following standard accessory cable for RS-232C.
If it is necessary to connect a cable to the MF-50 and ML-50, purchase the cable of accessory AX-MX-40. If purchasing the RS-232C cable on the market, check the interface connections and type.

RS-232C Cable Included As A Standard Accessory Of The MS-70 and MX-50
Length 2m, straight-through type for modem

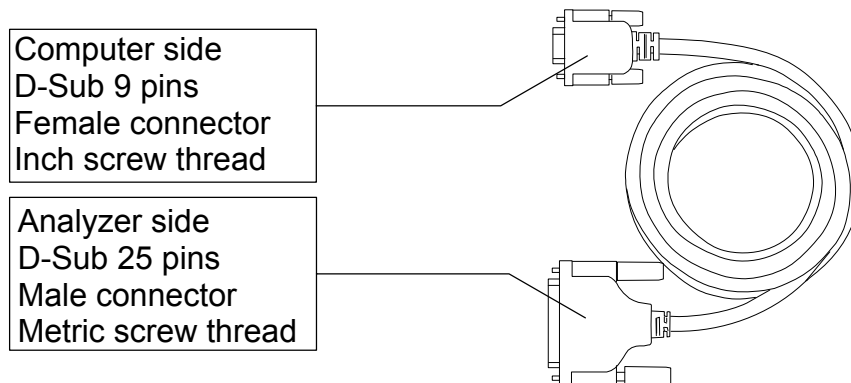

- The MS-70 and MX-50 have the standard accessory software "WinCT-Moisture" for Windows. It has the function to make graphs of the change of moisture content in realtime and has an optimum temperature search program that judges heating at an appropriate temperature setting. Refer to "English\Readme.txt" on the CD-ROM for the details.
- The MF-50 has the standard accessory software " WinCT" for Windows. It can transmit data to a computer and can be used to monitor data and to check the measurement condition.
- There is the accessory AX-MX-42 of the software " WinCT" for Windows.



10.1. RS-232C Serial Interface

RS-232C Serial Interface

- Transmission system EIA RS-232C
- Transmission form Asynchronous, bi-directional, half duplex
- Data format Baud rate 2400bps
- Data bits 7bits
- Parity EVEN
- Stop bit 1bit
- Code ASCII
- Terminator CR LF (CR: 0Dh, LF: 0Ah)
- Bit format

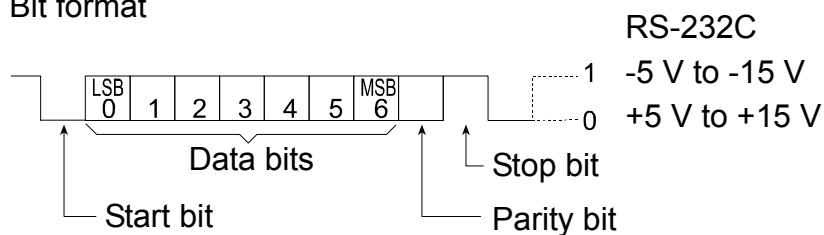

Pin Connections

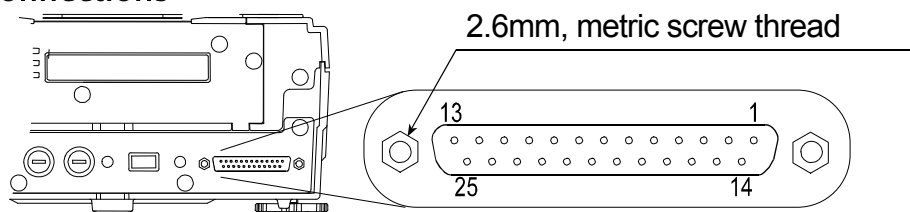

Pin No.	MX-50 and MF-50 (DCE)		Direction	Computer (DTE)
	Signal Name *2	Description		Signal Name
1	FG	Frame ground	-	FG
2	RXD	Receive data	←	TXD
3	TXD	Transmit data	→	RXD
4	RTS	Ready to send *3	←	RTS
5	CTS	Clear to send *3	→	CTS
6	DSR	Data set ready	→	DSR
7	SG	Signal ground	-	SG
16, 18, 19, 21, 23	Internal use		Do not connect *1	
Other	Not used			

*1: Normal DOS/V cables do not use these terminals.

*2: Signal names of the analyzer side are the same as the DTE side with TXD and RXD reversed.

*3: RTS and CTS control are not used. CTS output is HI always.



10.2. Output Format

In Case of Format omitted Temperature Data (Function Table 5-d 0)

- The format consists of fifteen characters except the terminator.
- A polarity sign is placed before the data with the leading zeros. If the data is zero, the plus sign is used.
- The unit is g or %.
- The position of decimal point and minimum display are changed by models.
- Sign of ASCII code

<input type="text"/>	0Dh	Carriage return
<input type="text"/>	0Ah	Line feed
<input type="text"/>	20h	Space

Sample Mass Format (Gram Display)

S	T	,	+	0	0	0	1	.	2	3	4	<input type="text"/>	<input type="text"/>	g	<input type="text"/>	<input type="text"/>
Header			Mass data							Unit		Terminator				

Positive Overload Format (Too heavy weighing, E display)

O	L	,	+	9	9	9	9	9	9	9	9	E	+	1	9	<input type="text"/>	<input type="text"/>
Header			Polarity Overload										Terminator				

Negative Overload Format (Too light weighing, -E display)

O	L	,	-	9	9	9	9	9	9	9	9	E	+	1	9	<input type="text"/>	<input type="text"/>
Header			Polarity Overload										Terminator				

Moisture Content (during weighing or after weighing)

In case of the MS-70

S	T	,	+	0	0	1	2	.	3	4	5	<input type="text"/>	<input type="text"/>	%	<input type="text"/>	<input type="text"/>
Header			Moisture content									Unit		Terminator		

In case of the MX-50 or MF-50

S	T	,	+	0	0	0	2	3	.	4	5	<input type="text"/>	<input type="text"/>	%	<input type="text"/>	<input type="text"/>
Header			Moisture content									Unit		Terminator		

In case of the ML-50

S	T	,	+	0	0	0	1	2	3	.	4	<input type="text"/>	<input type="text"/>	%	<input type="text"/>	<input type="text"/>
Header			Moisture content									Unit		Terminator		

In Case of Format included Temperature Data (Function Table 5-d 1)

- The first 3 figures are the temperature data.
The format consists of nineteen characters except the terminator.

In case of the MS-70

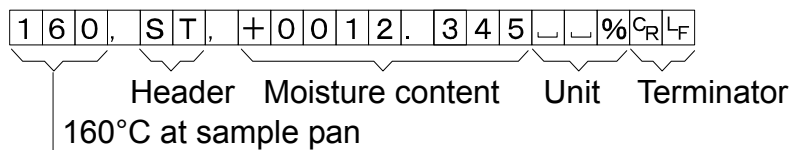

In case of the MX-50 or MF-50

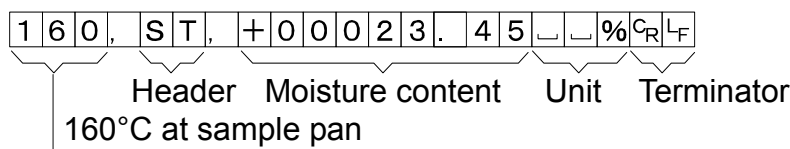

In case of the ML-50

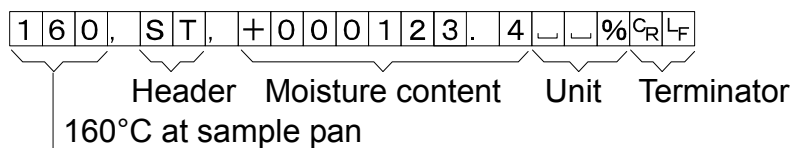

10.3. Command

- The analyzer can be controlled by the following commands from the computer.
Add a terminator C_RL_F (0Dh, 0Ah) to each command.

Command	Description
Q	Outputs the current data.
SIR	Outputs data continuously
C	Stops data output by SIR command.
QM	Outputs the data during measurement. (In other mode, QM can not use.)
START	Same as the START key
STOP	Same as the STOP key
RESET	Same as the RESET key
ENTER	Same as the ENTER key
SELECT	Same as the SELECT key
DOWN	Same as the ↓ key
UP	Same as the ↑ key
PROGRAM	Same as the PROGRAM key



11. Data Memory Function

- The data memory function automatically stores each result when finishing a measurement.

	MS-70 / MX-50	MF-50	ML-50
Maximum number	100 data	50 data	30 data

- The stored data can be output to a printer at one time and can be output to a computer using RsCom and Rskey that are Windows applications stored in the CD-ROM of WinCT-Moisture or WinCT at one time.
- The stored data can be deleted at one time.
- The function can select either storing each result or not at *data* of the function table.

Data is stored at each measurement..... data 1
 Data is not stored data 0

- When using the data memory function, MEM is displayed.
- When displaying FULL, the function can not store the next data. The function can store new data after deleting the stored data.

Caution

- When pressing the STOP key during a measurement except manual mode, the result is not stored.
- Set *data 1* before measurement, if it is necessary to store each result with data memory function.

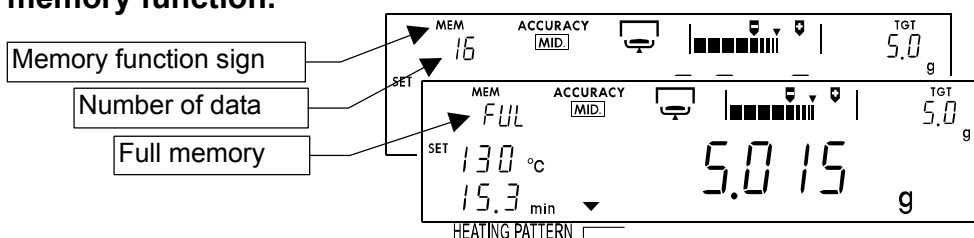

11.1.1. Preparation

This example selects "store result" at *data* of the function table.

1. Display the gram unit (of the weighing mode).

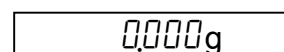

2. Press and hold the SELECT key to enter the function table.



3. Press the SELECT key to display data.



3. Press the SELECT key several times and press the ↓ or ↑ key to display data 1.

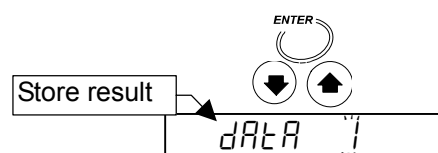

5. Press the ENTER key to store the new settings. Press the RESET key to return to the weighing mode. MEM is displayed when the memory function is effective.

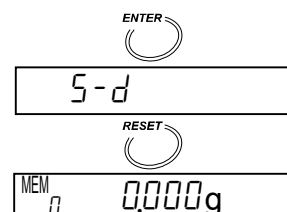

11.1.2. Output All Data at One Time

1. Display the gram unit (of the weighing mode).
2. Press and hold the **ENTER** key to display **out**.
3. Press the **ENTER** key to display **out no**.
4. Press the **↓** or **↑** key to display **out 0.0**.
5. Press the **ENTER** key to output the data in order.
Data is output to the peripheral equipment (printer or computer) connected to the RS-232C interface.
6. When output is finished, **End** is displayed.
7. Press the **RESET** key to return to the weighing mode.

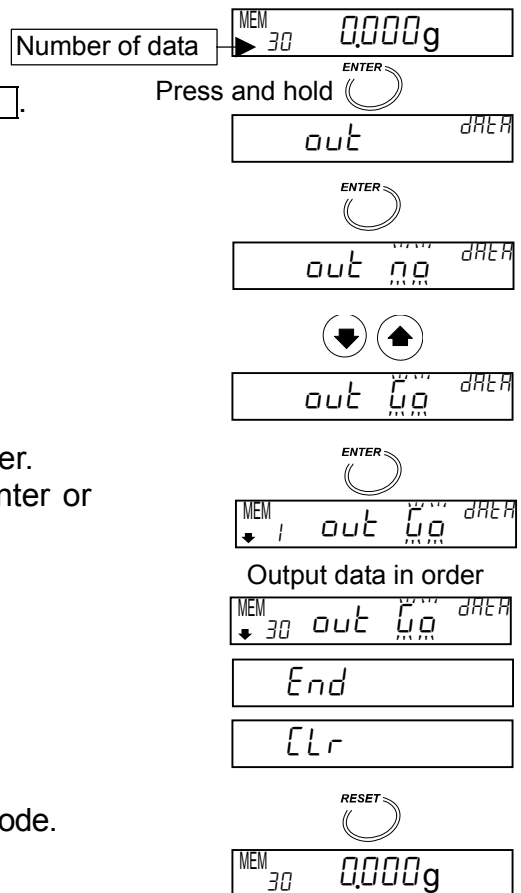

11.1.3. Delete All Data at One Time

1. Display the gram unit (of the weighing mode).
2. Press and hold the **ENTER** key to display **out**.
3. Press the **SELECT** key to display **Clr**.
Press the **ENTER** key to enter the mode.
4. Press the **↓** or **↑** key to display **Clr 0.0**.
5. Press the **ENTER** key to delete all stored data.
6. When deleting is finished, **End** is displayed.

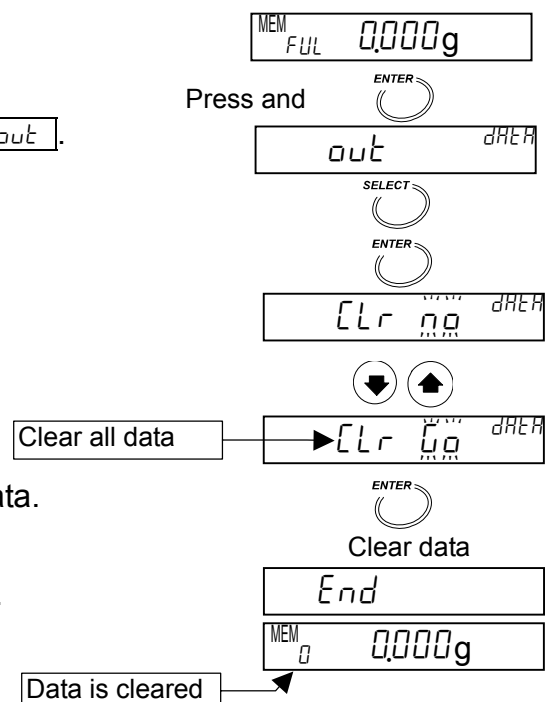



12. Calibration

- The moisture content is calculated with a ratio of wet weight and dried weight. Therefore, the absolute value of weighing does not influence the calculation of the moisture content, but it is necessary to get precise weighing for GLP, GMP and ISO. Use a 20g mass or a 50g mass to calibrate the weighing sensor.
- When calibrating the weighing sensor, you can output the calibration report adapted to GLP, GMP and ISO.
- There is a certified temperature calibrator (accessory AX-MX-43, only for MS-70 and MX-50) to calibrate the pan temperature for precise temperature control.
- When calibrating the temperature, you can output the calibration report adapted to GLP, GMP and ISO.
- The analyzer can store an ID number to be used in the calibration report. The number can be used for management and maintenance of the analyzer



12.1. Identification Number (ID No.)

- The ID number consists of the following seven characters.

Characters	0	1	2	3	4	5	6	7	8	9	Space	-(hyphen)
Display	0	1	2	3	4	5	6	7	8	9		-

Characters	A	B	C	D	E	F	G	H	I	J	K	L	M	N	O	P	Q
Display	A	b	c	d	E	F	G	H	I	J	K	L	M	N	O	P	Q

Characters	R	S	T	U	V	W	X	Y	Z
Display	r	S	t	U	V	W	X	Y	Z

12.1.1. Setting the ID Number

1. Turn on the analyzer.
The gram unit (of weighing mode) is displayed.
2. Press and hold the **SELECT** key to enter the function table. Then **CL Add** is displayed.
3. Press the **SELECT** key to display **id**.
4. Press the **ENTER** key.
5. Set the ID number using the following keys.
Example: *LAB-123*
SELECT keySelects a figure.
↓, ↑ key.....Selects a value for the figure.
ENTER key.....Stores the ID No. and proceeds to step 6.
6. Press the **RESET** key to return to the weighing mode.

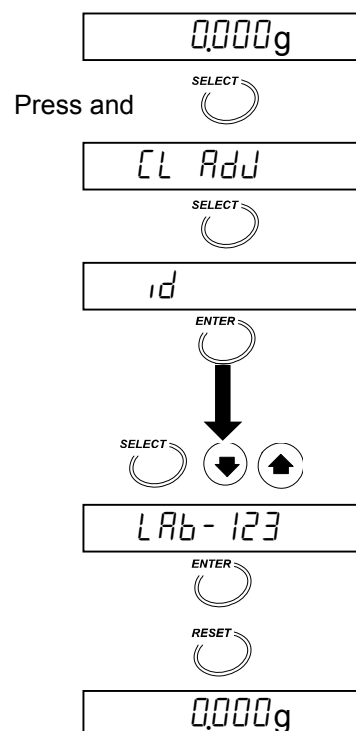



12.2. Calibration of the Weighting Sensor

- A standard mass of 20g or 50g can be used for the calibration
- A 20g standard mass (AX-MX-41) is recommend.

Caution

- **Avoid vibration and drafts that affect the calibration. If affected, the analyzer may be unable to calibrate the weighing sensor.**
- **Use a 20g mass for the calibration, because the height between the weighing pan and glass-housing is 26 mm. If a tall mass is used, open the glass-housing and avoid external influence.**

12.2.1. Operation

1. Display the gram unit (of the weighing mode).
2. Install the weighing pan, pan support and pan handle.
Close the heater cover.
3. Press and hold the **PROGRAM** key to display **[CH]**.
4. Press the **SELECT** key to display **[CAL]**.
5. Press the **ENTER** key to display **[CAL 0]**.
6. If 20g mass is used, Press the **ENTER** key.
Proceed to step 8.
If 50g mass is used, Press the **SELECT** key.
Proceed to step 7.
7. Press the **↓** or **↑** key to select 50.000g.
Press the **ENTER** key to store it.
[End], **[CAL 0]** are displayed in order.
8. When displaying **[CAL 0]**, press the **ENTER** key to input "Data to display ZERO". The standard mass value is displayed (Example: 20g).
9. Open the heater cover and put the standard mass on the center of the pan and press the **ENTER** key to input "mass value". **[End]** is displayed.
10. Remove the mass to return to the weighing mode
If the report for GLP, GMP and ISO is to be output (Refer to page 61), **[GLP]** is displayed.
The output condition for the report is selected in the function table.

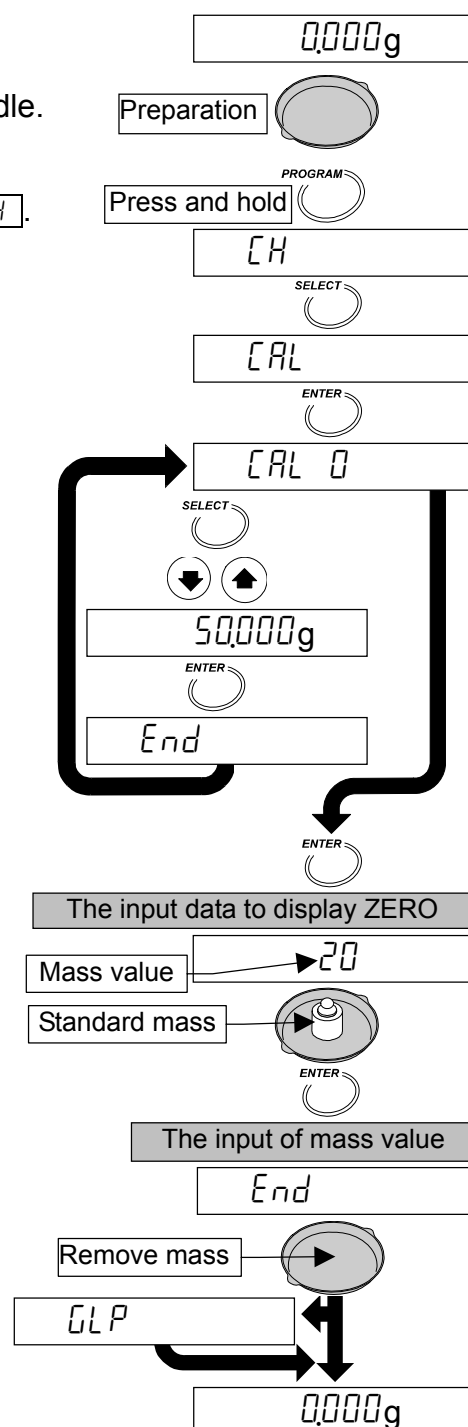

Calibration Report Example for the Weighing Sensor Adapted to GLP, GMP and ISO

Preset the following parameters to print data to AD-8121B

Device	Parameter	Description
Analyzer	Interval	<i>PULSE 1</i> *1
	Output format adapted to GLP, GMP and ISO	<i>info 1</i> or <i>info 2</i>
AD-8121B	MODE 3	Dump print (Received data is printed as it is)

*1: Factory settings

A & D	Manufacture
MODEL MX-50	Model
S/N K1234567	Serial number
ID LAB-123	ID number
DATE 2004/09/30	Date
TIME 13:57:24	Time
CALIBRATED	}	Calibration type
WEIGHT		
CAL.WEIGHT	}	Calibration mass
20.000 g		
SIGNATURE	Signature
- - - - -		



12.3. Calibration of Drying Temperature (for MS-70 and MX-50)

- The temperature calibrator (accessory AX-MX-43) adjusts the drying temperature on the pan. Put the sensor on the pan and input measurement data at 100°C and 160°C.
- Each adjustment needs fifteen minutes. The buzzer sounds at the end.
- **t-UP** is displayed after no adjustment for five minutes during the operation and calibration is stopped. Press any key to return to weighing mode.
- Refer to the instruction manual of the certified temperature calibrator (accessory AX-MX-43).

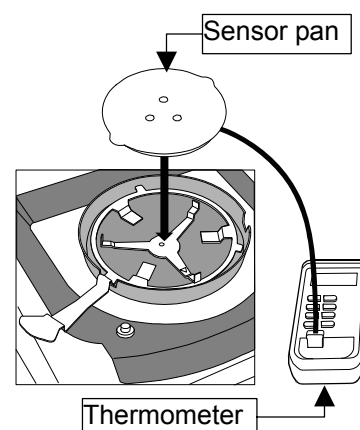

12.3.1. Operation

1. Replace the weighing pan with the sensor pan of the temperature calibrator.
2. Curve the sensor wire so it does not touch the heater cover and glass-housing when closing heater cover.
Level the sensor pan.
Do not leave a gap between the pan support and the sensor.

Level the sensor pan.
Curve the sensor wire so as not to touch heater cover.

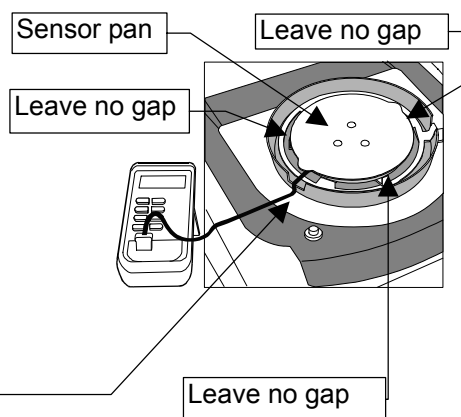

3. Turn on the analyzer.
Display the gram unit (of the weighing mode)
4. Press and hold the **PROGRAM** key
5. Press the **SELECT** key to display **t-CAL**.
6. Press the **ENTER** key.
7. Press the **START** key to start the 100°C measurement.
8. After fifteen minutes, the buzzer sounds and blinks **100°C**. Adjust the blinking value to the thermometer value using the **↓** or **↑** key. (Example: 97°C)
9. Press the **ENTER** key to store the new data and to start the 160°C measurement.

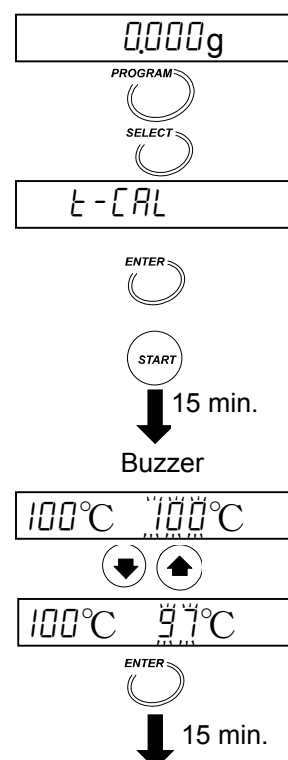

- After fifteen minutes, the buzzer sounds and the display blinks `160°C`. Adjust the blinking value to the thermometer value using the `↓` or `↑` key. (Example: 162°C)
- Press the `ENTER` key to store the new data, to finish the adjustment and to return to the weighing mode.

If the report for GLP, GMP and ISO is output, `GLP` is displayed. Output condition is selected in the function table.

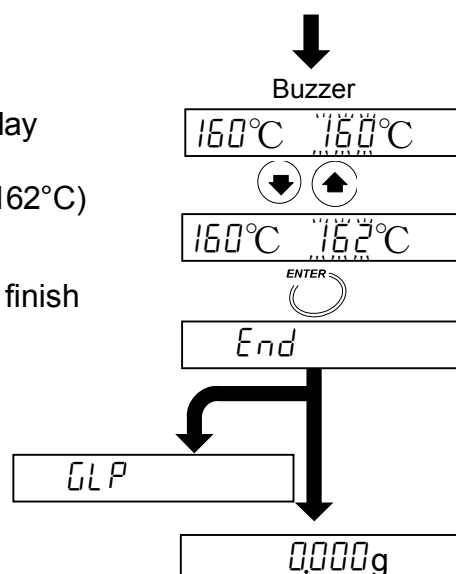

When the heater cover is opened during measurement or the `STOP` key is pressed, calibration is stopped and the analyzer displays the weighing mode.

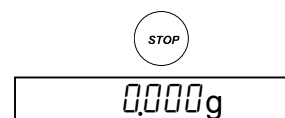

Calibration Report Example for Temperature Sensor Adapted to GLP, GMP and ISO

Preset the following parameters to print data to AD-8121B

Device	Parameter	Description
Analyzer	Interval	<i>PUSE 1</i> *1
	Output format adapted to GLP, GMP and ISO	<i>info 1</i> or <i>info 2</i>
AD-8121B	MODE 3	Dump print (Received data is printed as it is)

*1: Factory settings

A & D	Manufacture	
MODEL	MX-50	Model
S/N	K1234567	Serial number
ID	LAB-123	ID number
DATE	2004/09/30	Date
TIME	12:34:56	Time
CALIBRATED		}	Calibration type
TEMPERATURE			
TARGET	ACTUAL		
100 C	97 C	100°C target value measurement value
160 C	162 C	160°C target value measurement value
SIGNATURE		Signature
- - - - -			



13. Function Table

The function table can store the following parameters to control the analyzer.

Details of the Function Table

Item and Display Symbol	Parameter	Description		
Clock	<i>CL ADJ</i>	Set date and time for the built-in clock. Refer to "5.2. Setting the clock and calendar"		
Decimal point	<i>dP</i>	0 *1	Dot " . "	Select decimal point of data.
		1	Comma " , "	
Data output mode	<i>Prt</i>	0 *1	Key mode	Data is output by the <input type="button" value="ENTER"/> key
		1	Auto print mode	Data is output after measurement.
		2	Stream mode	Data is output continuously during measurement.
Data memory function	<i>dAtA</i>	0 *1	Not used.	
		1	Data is stored at each measurement	
Form selection	<i>S-d</i>	0 *1	Moisture content is output.	
		1	Moisture content and temperature are output.*2	
Interval	<i>PUSE</i>	0	Continuous output	
		1 *1	Output with approx. two seconds interval in each line.	
Output format adapted to GLP, GMP and ISO	<i>inFo</i>	0 *1	Not used	
		1	To output (print) items with "analyzer information", "measurement program", "measurement data" and ""signature space" at one time. *3	Output of calibration report. *5
		2	To output (print) items specified from "analyzer information", "measurement program" and "signature space". *4	
ID number	<i>id</i>	Set ID number. Used for the calibration report.		
Factory settings	<i>CLR</i>	Resets the analyzer to the factory settings.		

*1: Factory settings

*2: Use a computer because the AD-8121B printer can not print this correctly.

RsTemp and RsFig contained in the software "WinCT-Moisture" that is the standard accessory of the MS-70 and MX-50 can not output this correctly.

*3: Refer to "9.1.1. Example To Print The Whole Data At One Time".

*4: Refer to "9.1.2. Example To Print Selected Items".

*5: Calibration report is outputted in "Calibration of the Weighting Sensor" and "Calibration of Drying Temperature".

13.1.1. Operation

1. Display the gram unit (of the weighing mode).
2. Press and hold the **SELECT** key to enter the function table.

Select an Item

3. Select an item using the following keys.
 Example: Data output mode *Prt* is selected.
SELECT keySelects a figure.
ENTER key.....Enters to the selected item.
RESET key.....Cancels the operation and returns to the weighing mode.

Select a Parameter

4. Select a parameter using the following keys.
 Example: Auto print mode *Prt 1* is selected.
 ↓, ↑ keySelects a parameter.
ENTER key.....Stores the parameter and proceeds to the next item.
RESET key.....Cancels the operation and returns to the weighing mode.
5. If you want to finish the operation, press the **RESET** key to return to the weighing mode.

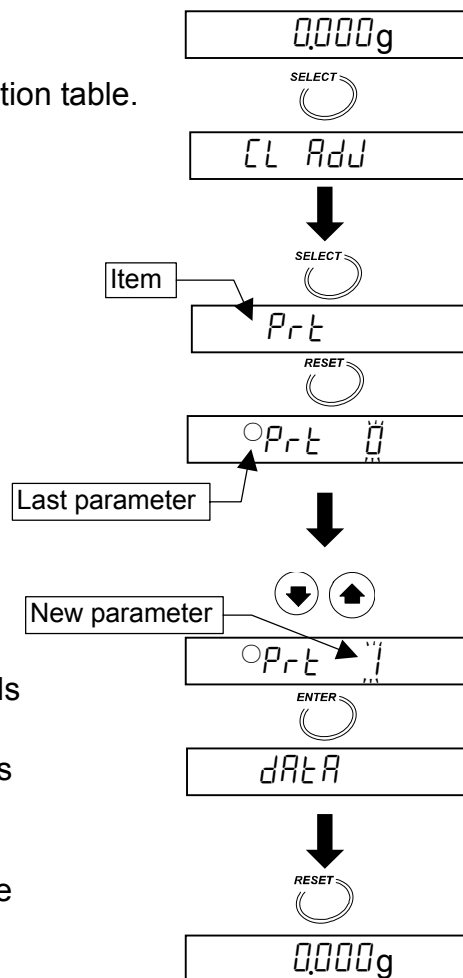

Example, Use Comma for Decimal Point

1. Press and hold the **SELECT** key to enter the function table.
2. Press the **SELECT** key to display *dP*.
3. Press the **ENTER** key to enter the item.
4. Press the ↓ or ↑ key to display *dP 1*.
5. Press the **ENTER** key to store the new parameter.
6. Press the **RESET** key to return to the weighing mode.

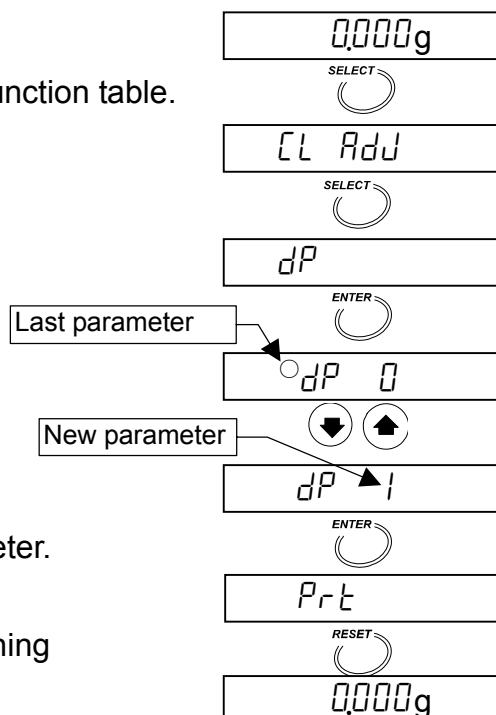



14. Maintenance

- ❑ Turn off the power switch and remove power cord during maintenance.
- ❑ Cool down all parts of the analyzer before maintenance.
- ❑ Pan support, sample pan and breeze break ring can be removed.
- ❑ Clean the analyzer with a lint free cloth that is moistened with warm water and a mild detergent.
- ❑ Do not use organic solvents to clean the analyzer.
- ❑ Dry the parts and reassemble them. Refer to "2. Precautions" and "5.1. Installing the Analyzer"
- ❑ Use the original packing material and box for transportation.

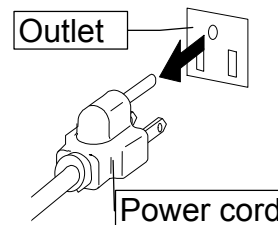
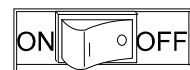

Example



14.1. Cleaning the Heater Unit

- ❑ Clean the glass-housing when it is stained (not clear) to maintain the drying performance.
- ❑ The glass-housing can be removed by removing two screws.
- ❑ Remove fingerprints from the halogen lamp to keep its life.
- ❑ Do not touch to reflective surface of the metal reflector. If the surface is touched, it may be the cause of a drying temperature error.
- ❑ Do not touch the temperature sensor that is at the side of halogen lamp. If the surface is touched, it may be the cause of a drying temperature error.

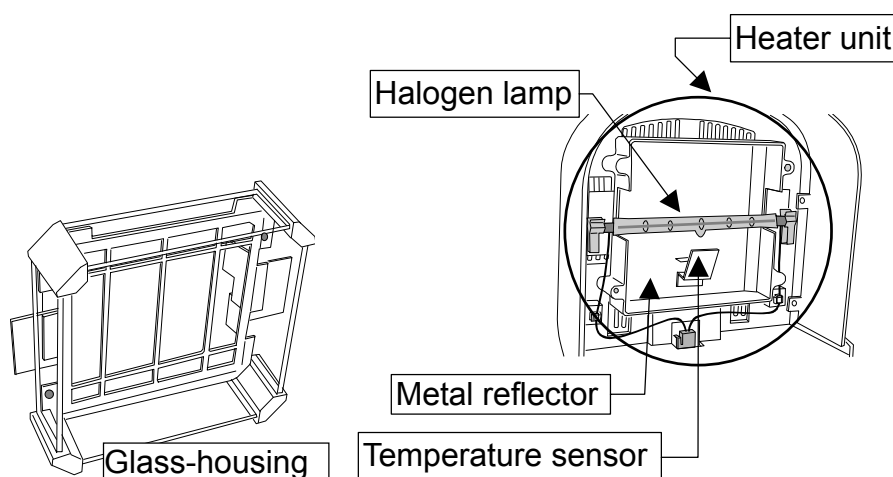
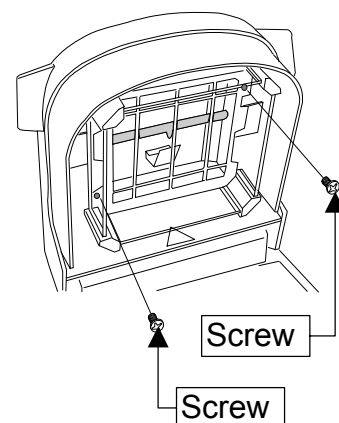



14.2. Replacement of the Halogen Lamp

- Replace the halogen lamp, when the drying time is excessive or the lamp is defective. Use the halogen lamp of accessory AX-MX-34-120V or AX-MX-34-240V that is adapted to your local voltage. The life of the halogen lamp is approximately 5000 hours.

Caution

- **Remove power cord before replacement. If the power cord is not removed during lamp replacement, it may cause receiving an electric shock.**
- **Read the power supply voltage label on the back of the heater cover and confirm that the rated voltage of the halogen lamp is correct for your power supply voltage.**

Voltage Label	The Rated Voltage of the Halogen Lamp	Accessory number
100 - 120 V	AC 120 V	AX-MX-34-120V
200 - 240 V	AC 240 V	AX-MX-34-240V

- **Do not drop, throw or crack the halogen lamp. Broken glass may cause an injury.**
- **Clean the surface of the halogen lamp. If there is a stain or fingerprint, it may shorten life of the halogen lamp. Do not touch the lamp directly.**
- **Dispose of a used halogen lamp that keeps its shape. If it is broken, glass may spread and cause injury.**
- **We recommend that you replace the halogen lamp, when it exceeds the rated life.**
- **Affix the lamp wire to the hook so that the lamp wire does not touch the glass-housing and heater cover.**

1. Turn off the power switch and remove power cord.

2. Check rated voltage of the halogen lamp that is printed around the holder.

3. Check that the lamp is cool.

4. Remove the two screws holding the glass-housing.

5. Remove halogen lamp.

6. Install the new halogen lamp so that there is downward projection of the heat and light.

7. Affix the lamp wire to the hook.

8. Affix the glass-housing with the two screws. Do not pinch the wire between the glass housing and lid.

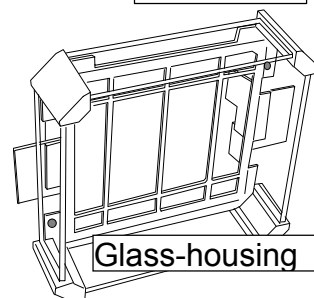
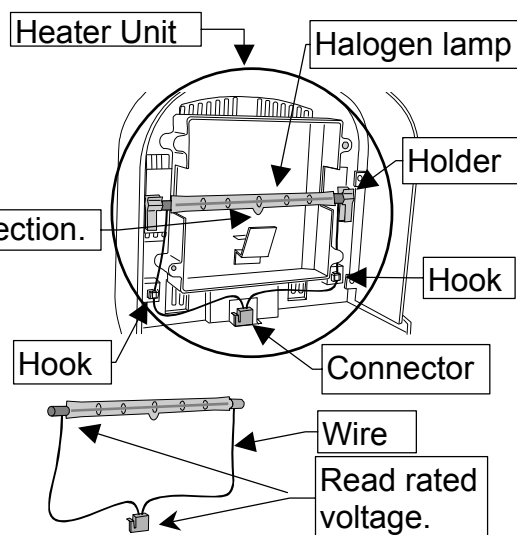
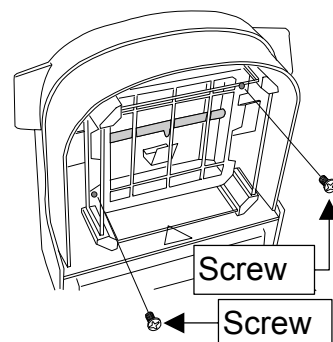



14.3. Factory Settings

This function can set the following parameters to factory settings.

- All measurement programs
- All results stored in memory function.
- All parameters of the function table
- ID number is reset to 0000000.
- Order of calendar and date.

14.3.1. Operation

1. Turn on the analyzer. The gram unit (of the weighing mode) is displayed.
2. Press and hold the **SELECT** key to enter the function table.
3. Press the **SELECT** key to display **CLr**.
4. Press the **ENTER** key to enter the item.
5. Press the **↓** or **↑** key to display **CLr 00**.

Caution

If pressing the **ENTER** key with **CLr 00** and pressing the **RESET** key, operation is canceled.

6. Press the **ENTER** key to reset. And **End** is displayed.
7. Press the **RESET** key to return to the weighing mode.

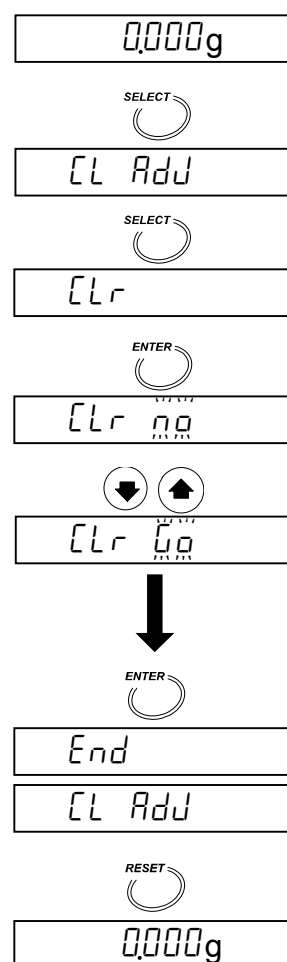



14.4. Troubleshooting

1. In the Case that Proper Results are not be Obtained.

- Use the self-check function. Refer to 8.1.Self-Check Function .
- Check repeatability. (Weigh the same mass several times in the weighing mode.) A taller mass may touch the glass-housing. Use a short mass if possible. If a tall 50g mass is used, open the heater cover and avoid external influence.
- The height from sample pan to glass-housing is 26 mm.
- Check whether the test sample can be measured correctly.
- Avoid the breeze from an air conditioner and vibration.
- Check sample condition. Refer to 5.3.Proper Operation for Precision Measurement
- Check measurement procedure and pre-heating process. Refer to 5.3.Proper Operation for Precision Measurement

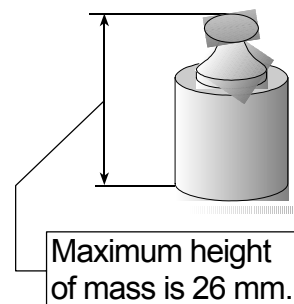

2. In Case that the Lamp does not Light or it takes Too Long to Reach the Drying Temperature.

- It requires six seconds to light the halogen lamp using the **START** key.
- When the heater cover is opened, power is not supplied to the halogen lamp.
- When an overheat has occurred, power is not supplied to the halogen lamp until the halogen lamp becomes cool.
- Check the rated voltage of the halogen lamp that is printed around the holder.
- Read the power supply voltage label on the back of the heater cover and confirm that the rated voltage of the halogen lamp is correct for your power supply voltage.

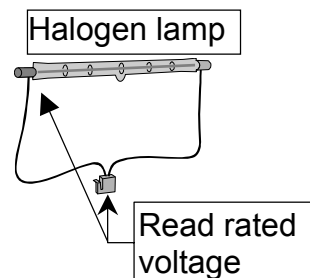

Voltage Label	Power Supply Voltage	The Rated Voltage of the Halogen Lamp	Accessory number
100 - 120 V	AC 100 V to AC 120 V	AC 120 V	AX-MX-34-120V
200V - 240 V	AC 200V to AC 240 V	AC 240 V	AX-MX-34-240V

- Is a fuse blown? Check the fuses after removing the power cord. Check the rated value and put new fuses into the correct holders.
- Do you measure a lower drying temperature after a high drying temperature? If the lamp is hotter than the drying temperature, the measurement can not be started.
- Check that the sample pan is cool.
- Other cases, the halogen lamp may be defective. Replace with a new halogen lamp. Refer to "14.2. Replacement of the Halogen Lamp".

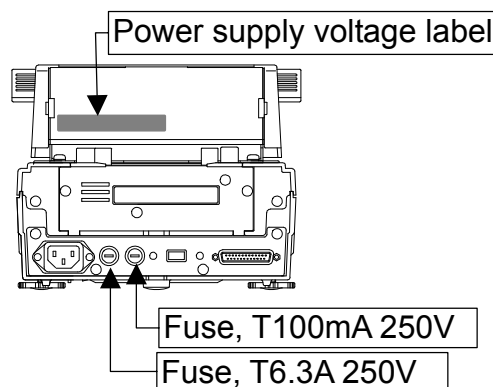



14.5. Error Message

[EH no]

Internal Error

An internal error indicated by the result of the self-check function. If repair is needed, contact the local A&D dealer.

[EL PF]

Clock Battery Error

Press any key and input the date and time. Refer to "5.2. Setting the Clock and Calendar".

[EL Err]

Clock Error

Contact the local A&D dealer to repair the analyzer.

[ELose]

Heater Cover Error

The heater cover is opened when starting self-check function. If it is closed, the self-check function is started.

[Error0]

Internal Error

Turn the power switch off and then on. Check the frequency of the power supply. Contact the local A&D dealer to repair the analyzer, if the error is not cleared.

[Error3]

IC Error

[Error8]

Contact the local A&D dealer to repair the analyzer.

[Error9]

[Ht Err]

Temperature Control Error

Contact the local A&D dealer to repair the analyzer, if an error is not cleared when turning the power switch off for more than a half hour and rechecking it.

[t-UP]

Time Error at Temperature Calibration

There is no key operation for five minutes during temperature calibration. If pressing any key, the weighing mode is displayed.

[E]

Positive Overload, Overweight

The sample has exceeded the weighing capacity. If the weighing sample pan is empty and this error is displayed, contact the local A&D dealer to repair the analyzer.

[-E]

Negative Overload, Sample Pan Error

The weight value is too light. Check the pan, pan support and press the **[RESET]** key. Calibrate the weighing sensor. If an error can be not cleared, contact the local A&D dealer to repair the analyzer.

[CAL E]

Unsuitable Calibration mass (Positive Error)

The calibration mass is too heavy. Confirm that anything does not touch to the pan, the calibration mass does not touch to the glass-housing of the heater cover and the calibration mass value is correct. When pressing any key or waiting for 15 seconds, the weighing mode is automatically displayed.

[-CAL E]

Unsuitable Calibration mass (Negative Error)

The calibration mass is too light. Confirm that anything does not touch to the pan and the calibration mass value is correct. When pressing any key or waiting for 15 seconds, the weighing mode is automatically displayed.

MEM

FUL

Full Memory

The number of results stored in memory has reached the upper limit. Clear the data to store the new results. Refer to "11. Data Memory Function".



15. Specifications

	MS-70	MX-50	MF-50	ML-50	
Measurement method	400 W halogen lamp, thermogravimetric analysis				
Drying temperature range at sample pan (Increments)	30°C to 200°C (1°C)	50°C to 200°C (1°C)			
Heating pattern	Standard drying, Ramp drying, Step drying, Quick drying			Standard drying, Quick drying	
Temperature calibration	By Accessory AX-MX-43		—		
Sample weight range	0.1 g to 71 g	0.1 g to 51 g			
Accuracy: Repeatability of measurement, (Standard deviation)					
Moisture content *1					
	over 5 g sample	0.01 %	0.02 %	0.05 %	0.1 %
	over 1 g sample	0.05 %	0.1 %	0.2 %	0.5 %
Weighing mode	0.0005 g	0.001 g	0.002 g	0.005 g	
Minimum reading					
Moisture content	0.001 %, 0.01 %, 0.1 %	0.01 %, 0.1 %	0.05%, 0.1 %, 1 %	0.1%, 1 %	
Weighing mode	0.0001 g	0.001g	0.002g	0.002g	
Measurement programs					
Analysis mode	Standard mode	Sample weight and termination value is automatically set with ACCURACY and % display. When drying rate reaches the termination value, measurement is automatically completed. (*2)			
		Standard drying, Ramp drying, Step drying	Standard drying		
	Quick mode	Sample weight and termination value is automatically set with ACCURACY and % display. When drying rate reaches the termination value, measurement is automatically completed. (*2)			
		Quick drying			
	Automatic mode	When drying rate is less than preset termination value, measurement is automatically completed. (*2)			
		Standard drying, Ramp drying, Step drying	Standard drying		
Timer mode	After heating for the preset drying time, measurement is automatically stopped. (1min. to 480 min.)				
	Standard drying, Ramp drying, Step drying	Standard drying			
Manual mode	When pressing the key at any time, measurement is stopped and the result is decided.				
	Standard drying, Ramp drying, Step drying	Standard drying			
Measurement unit	Moisture content (Wet-base)				
	Moisture content (Dry-base, Atro)				
	Dry content				
	Ratio				
	Weight (g)				
Number of memory	20 sets		10 sets	5 sets	
Data memory function	100 results		50 results	30 results	
Communication function	RS-232C serial interface				
Operation environment	5°C to 40°C (41°F to 104°F), 85%RH or less (no condensation)				
Sample pan	φ85 mm				

*1: After preheating the analyzer, the data can be obtained with approximately 5 g test sample (Sodium tartrate dihydrate) in standard mode (MID), standard drying, 160 °C

*2: When change of moisture content per one minute reaches the preset termination value, the measurement is completed.

	MS-70	MX-50	MF-50	ML-50
Power source, Maximum current (r.m.s), Maximum consumption	AC100V to 120V 3A or AC200V to 240V 1.5A, 50Hz or 60Hz, Approximately 400W *3			
External dimensions	215(W) x 320(D) x 173(H)mm, 8.46(W) x 12.60(D) x 6.81(H)in.			
Mass (Net weight)	Approximately 6kg (without accessories)			
Accessories	O : Standard accessory, — : Accessory by your order.			
Pan support	O	O	O	O
Breeze break ring	O	O	O	O
Display cover	O	O	O	O
Power cord *3	O	O	O	O
Spare fuse T100mA 250V	O	O	O	O
Spare fuse T6.3A 250V	O	O	O	O
Instruction manual	O	O	O	O
Dust cover	O	O	O	—
Test sample	O	O	O	—
Glass fiber sheets	O	O	O	—
Spoon	O	O	O	—
Tweezers	O	O	O	—
RS-232C serial interface cable	O	O	—	—
Sample pan	20	20	20	10
Pan handle	2	2	2	1
Disposable aluminum foil pan	100	100	100	100
CD-ROM *4	WinCT-Moisture	WinCT-Moisture	WinCT	—

*3: Please confirm that this analyzer is correct for your local voltage and receptacle type and the power cord.

*4: Application software for Windows.



15.1. Dimensions

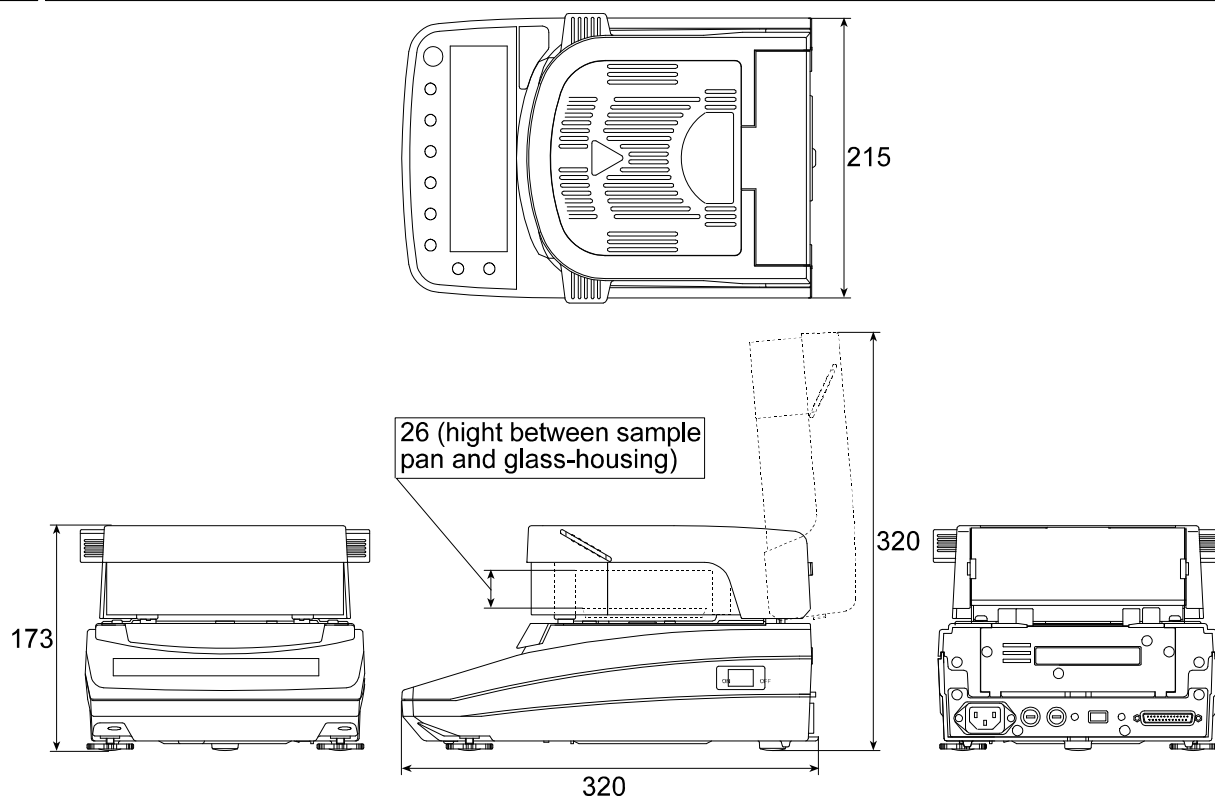



15.2. Accessories and Peripheral Equipment

Accessories

Name	Order number
Disposable aluminum foil pan (ϕ 83 mm, 100 pcs)	AX-MX-30
Sample pan (ϕ 85 mm, 100 pcs)	AX-MX-31
Glass fiber sheet, ϕ 70 mm, (Filter paper, 100 sheets) Use for high surface tension liquid sample.	AX-MX-32-1
Glass fiber sheet, ϕ 78 mm, (Glass paper, 100 sheets) The same sheet as accessory. Use liquid sample.	AX-MX-32-2
Test sample (Sodium tartrate dihydrate, 30gx12 pcs)	AX-MX-33
Halogen lamp for AC 100V to 120 V	AX-MX-34-120V
Halogen lamp for AC 200V to 240 V	AX-MX-34-240V
Pan handle (2 pcs)	AX-MX-35
Tweezers (2 pcs)	AX-MX-36
Spoon (2 pcs)	AX-MX-37
Display cover (5 pcs)	AX-MX-38
Dust cover	AX-MX-39
RS-232C cable (2m, 25 pins - 9 pins)	AX-MX-40
Calibration mass (20g, equivalent to OIML class F1)	AX-MX-41
WinCT-Moisture (CD-ROM: Application software for Windows)	AX-MX-42
Certified Temperature calibrator (only for MS-70 and MX-50)	AX-MX-43

Peripheral equipment

AD-8121B Dot matrix compact printer

Function: Statistical function, interval printing, chart printing,

Character: 5x7 dot, height 2.5mm/01.in., 16 characters/line

Power source: AC adaptor or alkaline batteries

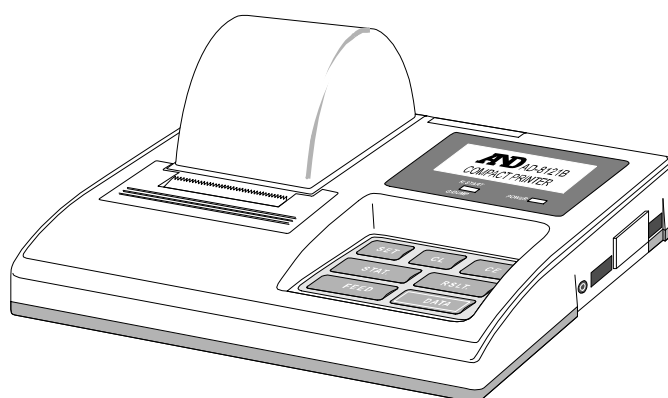



16. Index

%/min	19, 22, 27, 28
, ENTER key	14
, PROGRAM key	14
, RESET key	14
, SELECT key	14
, START key	14
, STOP key	14
and key	14
, Standard drying	13, 30, 43
, Ramp drying	13, 33, 35
, Step drying	13, 37, 39
, Quick drying	13
Sign Δ	15
, Operation state indicator	13
, Level indicator	13
ACCURACY	19, 22, 26, 27
AD-8121B	44, 70
Ambient condition	6
Analysis mode	9, 26
Analyzing mode	26, 28
Auto print mode	61
Automatic mode	9, 26, 28, 37, 39
Baud rate	51
Breeze break ring	7, 11, 12, 15
Bubble spirit level	11, 15
$[AL E$	67
$-[AL E$	67
Calendar	16
Calibration	56
Calibration report	58, 60
Cancel key	14
$[H$	42
$[H no$	67
$[H PASS$	42
Character	56
$[L PF$	67
$[L Add$	61
$[L Err$	67
$[LOSE$	42, 67
Clock	16, 61
$[Lr$	55, 61
$[Lr Go$	65

Comma	61
Command	53
Continuous measurement	17
CR	52
CTS	51
$dARA$	54, 61
Data bits	51
Data memory	54
Data memory function	61
Data output mode	61
Decimal point	61
Display	13
Display cover	12
Disposable aluminum foil pan	10, 11, 12, 15, 69, 70
dny	16
Dot	61
dP	61
Dried sample mass	29
Dry content	29
Drying program	9, 13, 28
Drying rate	26
Drying temperature	26, 29, 34, 36, 59
DSR	51
Dust cover	12
E	67
$-E$	67
Earth terminal	15
ENTER key	14
$Error 0$	67
$Error 3$	67
$Error 8$	67
$Error 9$	67
Factory settings	61
FG	51
$FULL$	54, 67
Fuse	11, 12
Glass fiber sheet	12, 18
Glass-housing	7, 11, 12, 64
GLP	57, 60
GLP	44, 57, 60, 61
GMP	44, 57, 60, 61
Gram value	29
Grip	7, 11
Halogen lamp	6, 9, 11, 12, 15, 64, 66
Header	52
Heater cover	11
HI	19, 22, 27
$Ht Err$	67

I/II-----	6	Report-----	58, 60
<i>i d</i> -----	61	RESET key-----	14
ID number-----	56, 61	RS-232C-----	11, 50, 51
Indicators-----	13	RTS-----	51
<i>i n F a</i> -----	61	RXD-----	51
ISO-----	44, 57, 60, 61	Sample mass-----	26
Key mode-----	61	Sample pan-----	7, 11, 12
Keys-----	13	<i>S - d</i> -----	52, 53, 61
Leveling foot-----	11, 15	SELECT key-----	14
LF-----	52	SG-----	51
<i>L i s t</i> -----	46	<i>S i G</i> -----	46
LO-----	19, 22, 27	Sodium tartrate dihydrate-----	43
Manual mode-----	9, 26, 28, 37, 39	Spoon-----	12
Mass-----	57, 66	Standard accessories-----	11, 12
<i>n d y</i> -----	16	Standard drying-----	9, 28, 30, 37, 39, 43
Measurement program-----	26	Standard mode-----	9, 26, 28, 37, 39
MEM-----	25, 54, 67	START key-----	14
MID-----	19, 22, 27	<i>S t d</i> -----	14, 26
MOIST /D-----	29	Step drying-----	9, 28, 37, 39
MOIST /W-----	29	Stop bit-----	51
Moisture content-----	29, 56, 61	STOP key-----	14
<i>o u t</i> -----	55	Stream mode-----	61
Output format-----	52, 61	<i>t - C A L</i> -----	59
Pan handle-----	11, 12, 15	Temperature-----	6
Pan support-----	11, 12, 15	Temperature sensor-----	59
Parity-----	51	Terminator-----	51, 52
Polarity-----	52	Test sample-----	11, 43
Power cord-----	11, 12	Thermogravimetric analysis-----	10
Power input-----	11	Thermometer-----	59
Power supply voltage label-----	6, 15, 66	Timer mode-----	9, 26, 28, 37, 39
Power switch-----	11, 15	Test sample-----	12
Pre-heating process-----	17	<i>t - U P</i> -----	67
Printer-----	44, 70	Tweezers-----	12
PROG-----	25	TXD-----	51
PROGRAM key-----	14	<i>U - A</i> -----	14, 26
<i>P r t</i> -----	61	<i>U - n</i> -----	14, 26
<i>q u c</i> -----	26	Unit-----	29, 52
Quick drying-----	28, 37, 39	<i>U - t</i> -----	14, 26
Quick mode-----	9, 26, 28, 37, 39	Weighing sensor-----	56, 57
Ramp drying-----	9, 28, 33, 35, 37, 39	Wet sample mass-----	29
Ratio-----	29	WinCT-----	9, 50
RATIO D/W-----	29	WinCT-Moisture-----	9, 50
RATIO W/D-----	29	<i>Y n d</i> -----	16
Reference card-----	11	Zero display-----	14
Repeatability-----	17		